



# 2023 Product Catalog

---

*MSRP Effective Oct. 1, 2023*

# SnapNrack<sup>®</sup>

877-732-2860

•

[www.SnapNrack.com](http://www.SnapNrack.com)

•

[contact@snapNrack.com](mailto:contact@snapNrack.com)

# SnapNrack®

## Pitched Roof

### **TopSpeed™ Mounting System | *Railless Mounting*** **5**

TopSpeed™ Components 6

Wire Management & Grounding 6

### **RL Universal | *Railless Mounting*** **7**

RL-U Components 8

SpeedSeal™ Track for RL Universal 8

SpeedSeal™ DeckTrack for RL Universal 8

Wire Management & Grounding 8

### **Ultra Rail | *Rail-based Mounting*** **9**

UR-40/60 Rail & Accessories 10

Flashing & L Foot Attachments 11

SpeedSeal™ Foot for Ultra Rail 11

SpeedSeal™ DeckFoot for Ultra Rail 11

AnchorFoot™ with DeckAnchor™ for Ultra Rail 11

Module Clamps & Array Skirt 12

Tile Roof Solutions 13

Wire Management Solutions 14

## Pitched Roof (continued)

### **MightyMount™ | Railless Mounting** **15**

MightyMount™ Comp-S 16

MightyMount™ Metal-T 16

## Flat & Metal Roofs

### **Ultra Rail Tilt System** **17**

**NEW** SnapNrack & S-5! Metal Roof Attachments 19

Metal Roof Attachments 19

Standoff Components & Accessories 19

### **Accessories** **20**

## Ground Mount

### **Series 200 | Ground Mount** **21**

Series 200 Rail & Structural Fittings 22

# SnapNrack Solar Mounting Solutions



## **Ultra Rail Roof Mount System** | *Rail-based Mounting*

---

The SnapNrack **Ultra Rail Roof Mount** portfolio satisfies virtually all residential roof types featuring labor saving components like the snap-in mounts and splices along with the open rail channel and accessories to create the industry's leading Wire Management Solutions.

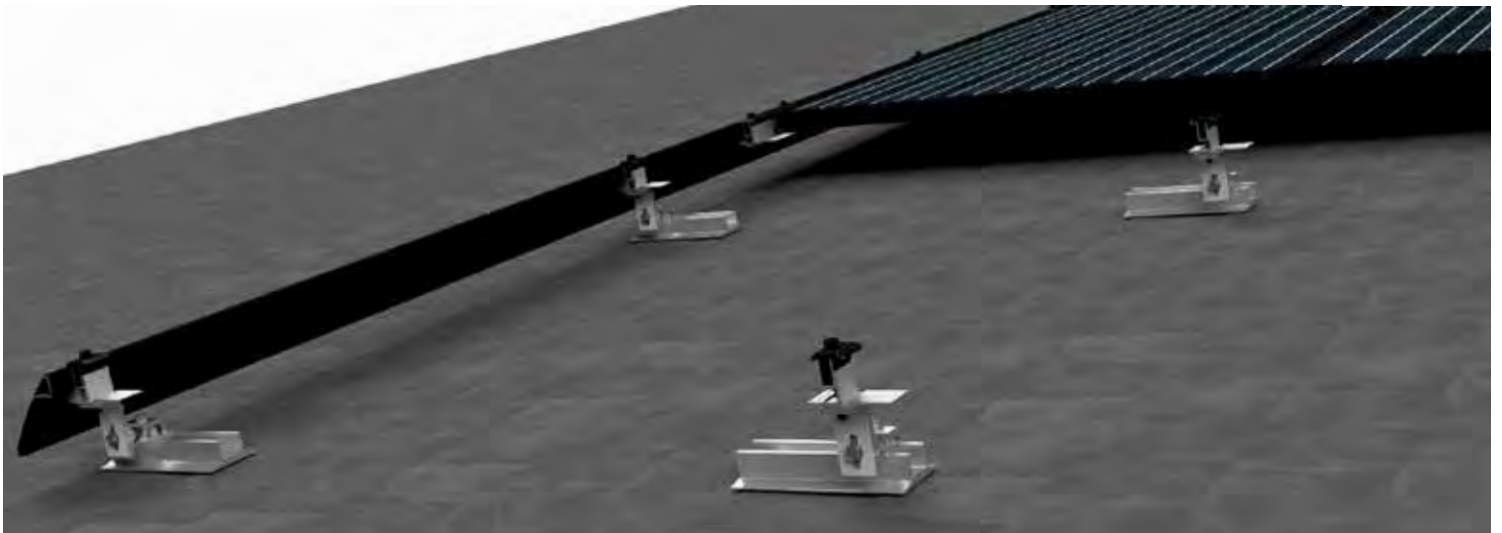

## **RL Universal Roof Mount System** | *Railless Mounting*

---

SnapNrack's **RL Universal System (RL-U)** for composition shingle roofs provides the greatest labor efficiency with an installer focused process allowing the system to be installed by a single person, saving time on the roof. This railless system was designed with an installer-focused approach, featuring Universal Mounts and nothing larger than a module.

## Flashing Based | Roof Attachment Technology

---

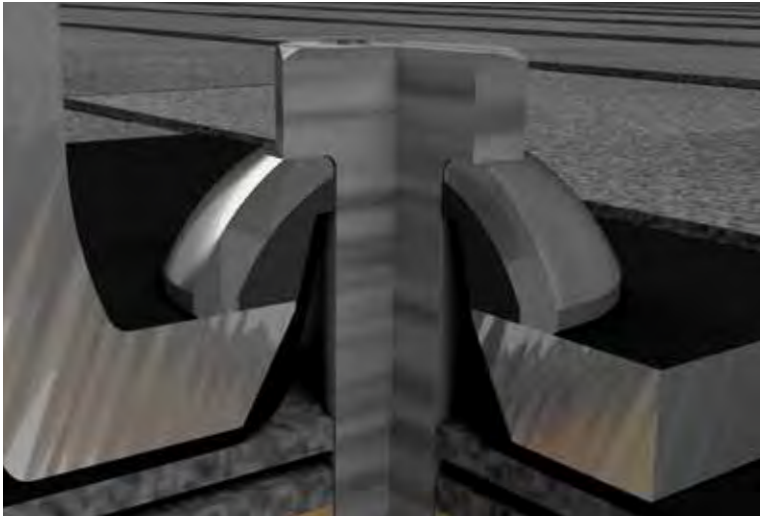

The SnapNrack **Umbrella Seal Technology** is an innovative flashing that uses a fully formed raised cone to prevent any water leakage. When paired with a single lag bolt & our Umbrella Washer, the Ultra Rail L Foot Mount is secured to the roof with the Umbrella Flashing in one step creating a multi-layer waterproof seal.

## Integrated Flashing | Roof Attachment Technology

---



SnapNrack's new **SpeedSeal™ Technology** features an innovative design that incorporates flashing reliability into a single roof attachment by using a patent pending Lag Driven Sealant Technology. The SpeedSeal™ Foot or Track has a sealant cavity with compressible barrier secures sealant in place & fills voids.

*Miami-Dade NOA NO: 20-1104.01*

## Direct to Deck | Roof Attachment Technology

---



Now **SpeedSeal™ Technology** applies to roof attachments that mount directly to the deck with the **SpeedSeal™ DeckFoot & DeckTrack**. These rafter independent attachments allow for layout adjustability on the roof without the need to locate & attach to rafters. More importantly, installers have the ability to mount on specialty roof structures without standard rafters.

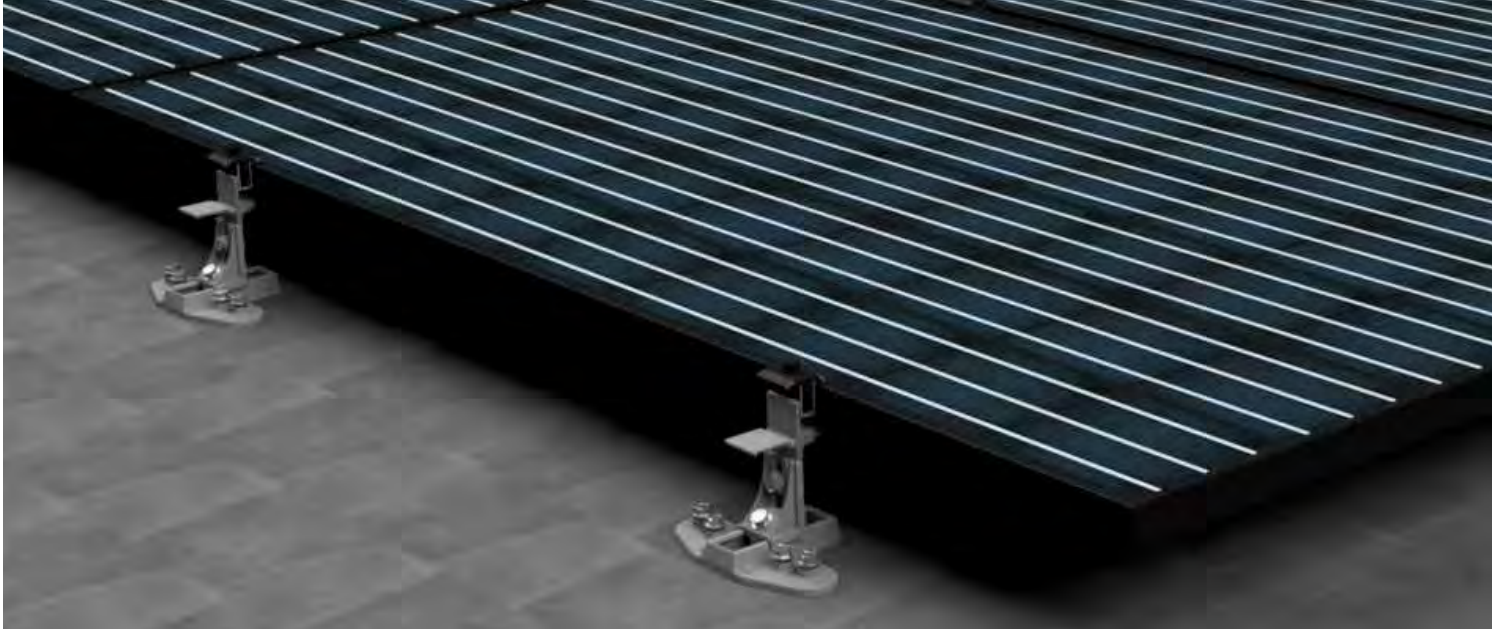

**NEW**

# TOPSPEED

**NEW**

## **SnapNrack TopSpeed™ Mounting System** **Time to revolutionize rooftop solar**

SnapNrack TopSpeed™ Mounting System is the future of solar racking installation for all installers. This game changing top down style mounting system allows installers to get on and off the roof in record time and safely. TopSpeed™ changes the way solar mounting hardware is installed by simplifying exhaustive layouts, eliminating the guesswork for locating rafters and pilot hole mistakes and saves time by no longer staging material on the roof.

- TopSpeed™ Mount is a preassembled mount that integrates three components into one - includes adjustable Track for North-South flexibility, Wood Fasteners, and Leveling Tower.
- The TopSpeed™ Mounts attach to modules on the ground to speed up the installation process & reduce time on the roof for safety concerns
- TopSpeed™ Clamp enables top down mounting installation with installer safety in mind and supports module overhangs in staggered arrays in place of an additional mount.
- The Universal Skirt features the familiar railless installation by easily locking to bottom row of mounts while ensuring a strong structure for leveling and alignment of first row of modules.

### **More Info**

[TopSpeed™ Product Page](#)

### **Visit Resource Library**

[Download Structural Engineering, Installation Manuals & System Drawings](#)

**NEW**



TopSpeed™ Mount



TopSpeed™ Clamp



Sealing Wood Screw



Smart Clip II



SpeedSeal™ J Box XL



SpeedSeal™ Conduit Mount Kit, 1" EMT

TopSpeed™ Components			
Description	SKU	MSRP	QTY*
TopSpeed™ Mount	242-10005	\$24.68	16 EA
TopSpeed™ Clamp	242-10011	\$6.50	20 EA
Universal Landscape Skirt, 70", Black (Bundle of 72, priced as each)	232-02492	\$45.97	72 EA
Universal Double Portrait Skirt, 83", Black, (Bundle of 72, priced as each)	232-02493	\$52.67	72 EA
Universal Skirt Spacer, 30 mm (Green)	232-02532	\$1.00	20 EA
Universal Skirt Spacer, 32 mm (Silver)	232-02494	\$1.00	20 EA
Universal Skirt Spacer, 35 mm (Gold)	232-02495	\$1.00	20 EA
Universal Skirt Spacer, 38 mm (Blue)	232-02496	\$1.00	20 EA
Universal Skirt Spacer, 40 mm (Black)	232-02497	\$1.00	20 EA
Sealing Wood Screw, #14 X 2¼", ½" HEX, SS (80 Pack)	015-30008	\$60.00	1 EA

TopSpeed™ Wire Management & Accessories			
Description	SKU	MSRP	QTY*
SnapNrack Grounding Lug	242-92202	\$4.70	20 EA
MLPE Frame Attachment Kit	242-02151	\$4.68	20 EA
Smart Clip II	232-01173	\$0.44	100 EA
Smart Clip XL	232-01176	\$0.61	100 EA
Wire Saver	242-92262	\$2.82	20 EA
Flash Track Universal Wire Clamp	242-92641	\$6.44	20 EA
Universal J Box Wire Clamp	242-09025	\$4.27	1 EA
SpeedSeal™ Conduit Mount Kit, ¾" EMT	242-05164	\$9.10	20 EA
SpeedSeal™ Conduit Mount Kit, 1" EMT	242-05165	\$9.91	20 EA
Conduit Support Assembly, ¾" EMT	242-02730	\$5.70	20 EA
Conduit Support Assembly, 1" EMT	242-02731	\$6.21	20 EA
Conduit Support Assembly, ¾" PVC	242-02732	\$5.70	20 EA
Conduit Support Assembly, 1" PVC	242-02733	\$6.21	20 EA
SpeedSeal™ J Box XL, Comp Mount	242-92128	\$52.50	1 EA
Junction Box XL with Comp Kit	242-92121	\$54.95	1 EA
Add-A-Lip Box Frame Adapter, Black	242-01101	\$12.11	20 EA

 For additional Universal Skirt SKUs and QTYS, please refer to the **RL-U Skirt Components Table** on page 8.

For additional railless Wire Management Solutions & Accessories, please refer to the **RL-U Wire Management & Accessories Table** on page 8.

\* QTY (Quantity) listed is the standard package and minimum order quantity. SnapNrack products are sold through distribution and may be available as individual units.

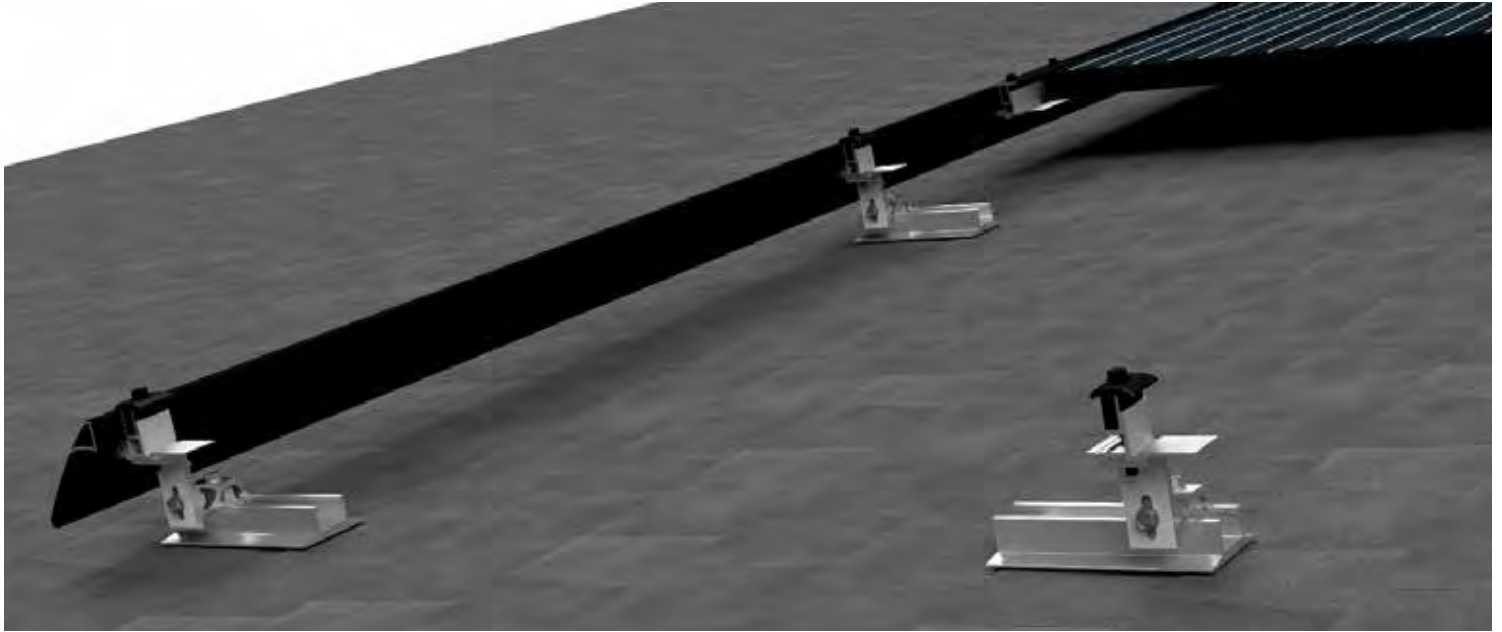

## SnapNrack RL Universal The Fastest Mounting System. Period

SnapNrack RL Universal Mounting System is designed to provide the fastest, most intuitive install experience on the roof. The direct mount system features four basic components for easy material management. Features incredible flexibility with a single Universal Mount that fits module heights from 30 - 40 mm and the highest spans of any current rail less system. The installer focused process allows the system to be installed by a single person.

- The RL Universal Skirt ensures a strong structure for leveling and alignment of first row of modules.
- Both SpeedSeal™ Technology or Umbrella Seal Technology roof attachments are designed for maximum versatility with 6" of North-South adjustability for all Mounts.
- A single Umbrella Lag screw secures flashing & Flash Track to roof in one complete action.
- A single Mount is used at all locations on array and eliminates Mount/Link interference, bypassing the need for hybrid mounts found in competitive systems.
- The Links clamp onto the top of modules securing them in place while providing row-to-row bonding.

### More Info

[RL Universal Product Page](#)

### RL Universal Configuration Tool

Design a system & download a BOM to quote with the online Configuration Tool

### Visit Resource Library

Download Structural Engineering, Installation Manuals & System Drawings





# RL-U Components



RL-U Flash Track with Flashing & Mount  
(All Sold Separately)



RL-U Skirt with Mount, Flash Track & Spacers  
(All Sold Separately)



RL-U SpeedSeal™ Track with Mount  
(All Sold Separately)



RL-U SpeedSeal™ DeckTrack  
(Bottom view)



RL Universal Link



Smart Clip XL

## RL-U Skirt Components

Description	SKU	MSRP	QTY*
Universal Landscape Skirt, 70", Black (Bundle of 72, priced as each)	232-02492	\$45.97	72 EA
Universal Double Portrait Skirt, 83", Black, (Bundle of 72, priced as each)	232-02493	\$52.67	72 EA
Universal Skirt Frame Mount	242-10006	\$8.00	20 EA
Universal Skirt Cap	232-10019	\$2.40	20 EA
Universal Skirt Spacer, 30 mm (Green)	232-02532	\$1.00	20 EA
Universal Skirt Spacer, 32 mm (Silver)	232-02494	\$1.00	20 EA
Universal Skirt Spacer, 35 mm (Gold)	232-02495	\$1.00	20 EA
Universal Skirt Spacer, 38 mm (Blue)	232-02496	\$1.00	20 EA
Universal Skirt Spacer, 40 mm (Black)	232-02497	\$1.00	20 EA

## RL-U Mount Components

Description	SKU	MSRP	QTY*
RL Universal Flash Track	232-01371	5.00	20 EA
Comp Flashing, 9" x 12", Black Alum (requires Umbrella Lag)	232-01375	\$6.06	20 EA
Comp Flashing, 9" x 12", Silver Alum (requires Umbrella Lag)	232-01376	\$5.03	20 EA
Comp Flashing, 9" X 12", Black Galvalume (requires Umbrella Lag)	232-01377	\$5.20	20 EA
Umbrella Lag, 4"	242-92266	\$1.55	20 EA
RL Universal SpeedSeal™ Track	232-01464	\$8.75	20 EA
Sealing Washer Lag, 4 1/2", SS	242-02168	\$1.25	20 EA
RL Universal SpeedSeal™ DeckTrack	242-02171	\$11.00	20 EA
Sealing Washer Wood Screw, #14 X 2¾", SS	242-02175	\$1.00	40 EA
Sealing Wood Screw, #14 x 2¼", ½" HEX, SS (80 pack)	015-30008	\$60.00	1 EA
RL Universal Mount	242-02155	\$12.41	20 EA
RL Universal Link	242-02156	\$14.79	20 EA

## RL-U Wire Management & Accessories

Description	SKU	MSRP	QTY*
Smart Clip II	232-01173	\$0.44	100 EA
Smart Clip XL	232-01176	\$0.61	100 EA
Wire Saver	242-92262	\$2.82	20 EA
Junction Box XL with Comp Kit	242-92121	\$49.95	1 Kit
Universal Wire Clamp for J Box	242-09025	\$4.27	1 EA
MLPE Frame Attachment Kit	242-02151	\$4.68	20 EA
Flash Track Universal Wire Clamp	242-92641	\$6.44	20 EA
RL Flash Track Leveling Spacer	242-92254	\$8.98	20 EA
Add-A-Lip Box Frame Adapter, Black	242-01101	\$12.11	20 EA

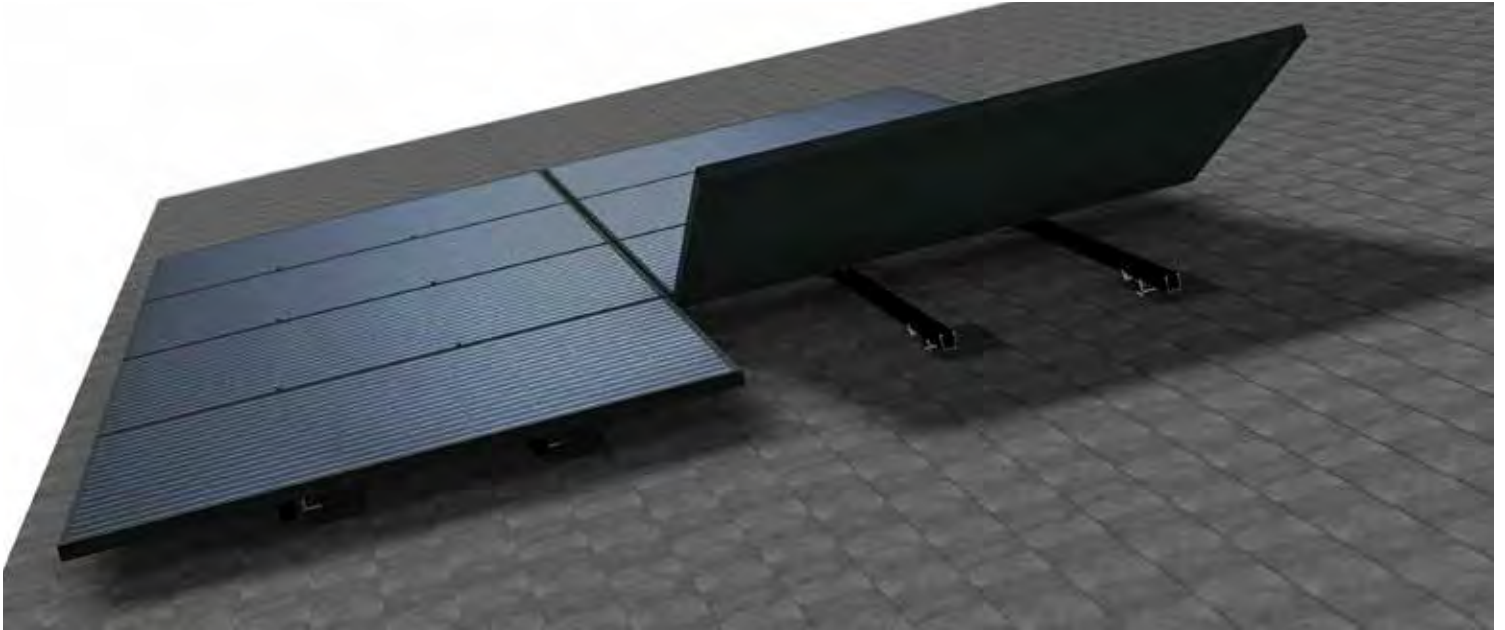

## **SnapRack Ultra Rail** **The Ultimate Value in Rooftop Solar**

Ultra Rail is the ultimate rail solution for mounting solar modules on the roof. The entire system is a snap to install utilizing new pre-assembled Ultra Rail Mounts that include snap-in brackets for attaching rail. Snap-in module clamps provide an intuitive install experience installers know and love.

- Industry-leading aesthetics with Universal End Clamps and snap-in End Caps that make the mounting system invisible underneath the array.
- Unparalleled wire management solutions with accessories such as Junction Boxes, Universal Wire Clamps, MLPE Attachment Kits, and Conduit Clamps.
- Low profile rail maintains the open channel with room for running wires resulting in a top quality finished install.
- UR-40 has the largest span capabilities of any light rail solution.
- UR-60 is a heavy duty profile for higher loading conditions.

### **More Info**

[Ultra Rail Product Page](#)

### **Ultra Rail Configuration Tool**

Design a system & download a BOM to quote with the online Configuration Tool

### **Visit Resource Library**

Download Structural Engineering, Installation Manuals & System Drawings

# UR-40/60 Rail & Accessories



UR-40 Rail, Black

**NEW**



UR-40 Splice



UR-40 End Cap



UR-60 Rail, Black



UR-60 Splice



UR-60 End Cap

## UR-40 Rail

Description	SKU	MSRP	QTY*
UR-40 Rail, 86", Black (Bundle of 144, priced as each)	232-02551	\$30.46	144 EA
UR-40 Rail, 86", Mill (Bundle of 144, priced as each)	232-02550	\$27.88	144 EA
UR-40 Rail, 172", Black (Bundle of 144, priced as each)	232-02538	\$60.91	144 EA
UR-40 Rail, 172", Silver (Bundle of 144, priced as each)	232-02537	\$59.79	144 EA
UR-40 Rail, 172", Mill (Bundle of 144, priced as each)	232-02536	\$55.75	144 EA

## UR-60 Rail

Description	SKU	MSRP	QTY*
UR-60 Rail 172", Black (Bundle of 120, priced as each)	232-02541	\$79.81	120 EA
UR-60 Rail 172", Silver (Bundle of 120, priced as each)	232-02540	\$78.96	120 EA
UR-60 Rail 172", Mill (Bundle of 120, priced as each)	232-02539	\$78.66	120 EA

## UR-40 Rail Accessories

Description	SKU	MSRP	QTY*
UR-40 Splice, Silver	242-01213	\$8.70	20 EA
UR-40 Splice, Black	242-01214	\$9.24	20 EA
UR-40 End Cap	232-02452	\$0.70	20 EA

## UR-60 Rail Accessories

Description	SKU	MSRP	QTY*
UR-60 Splice, Silver	242-01270	\$11.49	20 EA
UR-60 Splice, Black	242-01271	\$11.83	20 EA
UR-60 End Cap	232-02484	\$0.70	20 EA

\* QTY (Quantity) listed is the standard package and minimum order quantity. SnapRack products are sold through distribution and may be available as individual units.

# Flashing & L Foot Attachments



Ultra Rail Umbrella L Foot with Comp Flashing (Sold Separately)



UR SpeedSeal™ Foot, Black



UR SpeedSeal™ DeckFoot, Black



AnchorFoot™



DeckAnchor™ 2.5



Ultra Rail Leveling Spacer

## Composition Shingle Attachments

Description	SKU	MSRP	QTY*
Ultra Rail Umbrella L Foot, Silver	242-01219	\$6.30	20 EA
Ultra Rail Umbrella L Foot, Black	242-01220	\$7.74	20 EA
Comp Flashing, 9" x 12", Black Alum (requires Umbrella Lag)	232-01375	\$5.51	20 EA
Comp Flashing, 9" x 12", Silver Alum (requires Umbrella Lag)	232-01376	\$4.57	20 EA
Comp Flashing, 9" X 12", Black Galvalume (requires Umbrella Lag)	232-01377	\$4.73	20 EA
Umbrella Lag, 4"	242-92266	\$1.55	20 EA
UR SpeedSeal™ Foot, Silver	242-02163	\$9.50	20 EA
UR SpeedSeal™ Foot, Black	242-02167	\$10.50	20 EA
Sealing Washer Lag, 4 1/2", SS	242-02168	\$1.25	20 EA
UR SpeedSeal™ DeckFoot, Silver	242-02173	\$13.50	20 EA
UR SpeedSeal™ DeckFoot, Black	242-02174	\$14.75	20 EA
Sealing Washer Wood Screw, #14 x 2 3/4", SS	242-02175	\$1.00	40 EA
Sealing Wood Screw, #14 x 2 1/4", 1/2 HEX, SS, (80 pack)	015-30008	\$60.00	1 EA
Ultra Rail AnchorFoot™, Black	242-10038	\$11.50	20 EA
DeckAnchor™ 2.5	242-10035	\$1.80	40 EA

## Ultra Rail Attachment Components

Description	SKU	MSRP	QTY*
Ultra Rail Leveling Spacer, Black	242-05161	\$2.87	20 EA
Ultra Rail Mounting Hardware, Black	242-01230	\$4.24	20 EA
Ultra Rail Mounting Hardware, Silver	242-01229	\$4.08	20 EA
Ultra Rail All Purpose L Foot (90°), Black	242-01239	\$7.04	20 EA
Ultra Rail All Purpose L Foot (90°), Silver	242-01223	\$7.01	20 EA



**Note that the fasteners are sold separately from the Composition Shingle Roof Attachments listed above. Required fasteners are as follows:**

One (1) Umbrella Lag, 242-92266, is required for each Ultra Rail Umbrella L Foot & Comp Flashing attachment.

One (1) Sealing Washer Lag, 242-02168, is required for each Ultra Rail SpeedSeal™ Foot attachment.

Four (4) Sealing Washer Wood Screws, 242-02175, are required for each Ultra Rail SpeedSeal™ DeckFoot attachment.

# Module Clamps & Array Skirt

## SnapNrack Module Attachments - Ultra Rail - MightyMount™ - S200

**Module Clamps** are available for all PV module frame sizes (30-46 mm). **Universal End Clamps** are a unique one-size-fits-all that slips inside the module frame – completely out of sight. The rails are cut flush with the modules and finished with SnapNrack End Caps to create a system with a flush, clean line. All Module Clamps work with Ultra Rail, MightyMount™ and Series 200 Ground Mount. Module Clamps ship pre-assembled, ready to install.



Ultra Rail Mid Clamp,  
Black



Universal End Clamp



Ultra Rail End Clamp,  
Black



Universal Skirt Frame  
Mount



Universal Skirt Cap

### Mid Clamps

Description	SKU	MSRP	QTY*
Ultra Rail Mid Clamp, Silver	242-02070	\$4.64	20 EA
Ultra Rail Mid Clamp, Black	242-02071	\$4.87	20 EA

### End Clamps

Description	SKU	MSRP	QTY*
Universal End Clamp	242-02215	\$6.28	20 EA
Ultra Rail End Clamp, Silver	242-02072	\$5.77	20 EA
Ultra Rail End Clamp, Black	242-02073	\$6.06	20 EA

### Array Skirt

Description	SKU	MSRP	QTY*
Universal Skirt Frame Mount	242-10006	\$8.00	20 EA
Universal Skirt Cap	232-10019	\$2.40	20 EA
Universal Double Portrait Skirt, 83", Black, (Bundle of 72, priced as each)	232-02493	\$52.67	72 EA

\* QTY (Quantity) listed is the standard package and minimum order quantity. SnapNrack products are sold through distribution and may be available as individual units.

# Tile Roof Solutions



Ultra Rail Tile Roof Hook F



Ultra Rail Adjustable Tile Hook



Tile Hook Replacement Flashing, S



Tile Hook Replacement Flashing, W

Tile Roof Hooks			
Description	SKU	MSRP	QTY*
Ultra Rail Tile Roof Hook F	242-01247	\$11.95	20 EA
Ultra Rail Tile Roof Hook WS	242-01248	\$15.62	20 EA
Ultra Rail Adjustable Tile Hook	242-02729	\$16.38	10 EA
Sealing Washer Wood Screw, #14 X 2 <sup>3</sup> / <sub>4</sub> ", SS	242-02175	\$1.00	40 EA



Ultra Rail Adjustable Tile Hook is the one Tile Hook for all tile roofs with install compatibility on S/W and Flat tile profiles.

Ultra Rail Tile Roof Hook F is for application on flat tile roofs only. Ultra Rail Tile Roof Hook WS is for application on both W & S Shaped tile roofs.

Ultra Rail Tile Hooks ship pre-assembled with the Ultra Rail Mount.

Ultra Rail Adjustable Tile Hook & Ultra Rail Tile Roof Hook WS can be mounted directly to the roof deck with the use of 6 to 8 Sealing Washer Wood Screws (242-02175).

Tile Hook Replacement Flashing			
Description	SKU	MSRP	QTY*
Tile Hook Replacement Flashing, Flat	232-60055	\$15.93	20 EA
Tile Hook Replacement Flashing, S	232-60056	\$15.93	20 EA
Tile Hook Replacement Flashing, W	232-60057	\$15.93	20 EA



Ultra Rail Tile Hook Replacement Flashings are for Tile Hook installations when necessary to replace broken tiles.

Deck Level Flashing for Tile			
Description	SKU	MSRP	QTY*
PS45 Deck Level Flashing Set, (1) 9x9 & (1) 4X13	242-02723	\$7.98	20 Sets
PS45 Deck Level Flashing Set, (1) 5X13 & (1) 4X17	242-02728	\$8.98	20 Sets
Protecto-Tak Spray Adhesive	131-01347	\$32.99	20 EA

\* QTY (Quantity) listed is the standard package and minimum order quantity. SnapRack products are sold through distribution and may be available as individual units.

# Wire Management Solutions

## SnapNrack Wire Management - Ultra Rail - S200

SnapNrack offers the largest set of mounting accessories to enhance the install process. SnapNrack **Wire Management Solutions** comprise a set of dedicated components to reliably and cost-effectively secure PV module and microinverter leads. All components are made of materials which have been selected for their ability to handle high UV exposure and extreme rooftop temperatures common under solar arrays.



Junction Box XL



SpeedSeal™ J Box XL



Wire Retention Clip



Smart Clip II



Universal Wire Clamp



Ground Lug R,  
6-12 AWG



SpeedSeal™ Conduit  
Mount Kit, 1" EMT



Conduit Support  
3/4" EMT



Conduit Support -  
Tile

### Wire & Electronics Management

Description	SKU	MSRP	QTY*
Junction Box R for Rail	242-01104	\$35.11	1 EA
Junction Box XL for Rail	242-92120	\$47.20	1 EA
Junction Box XL with Comp Kit	242-92121	\$54.95	1 Kit
SpeedSeal™ J Box XL, Comp Mount	242-92128	\$52.50	1 EA
Universal Wire Clamp for Rail	242-02150	\$4.06	20 EA
Universal Wire Clamp for J Box	242-09025	\$4.27	1 EA
Snap-in Wire Retention Clip	232-01106	\$0.47	20 EA
Smart Clip II	232-01173	\$0.44	100 EA
Smart Clip XL	232-01176	\$0.61	100 EA
MLPE Rail Attachment Kit	242-92093	\$2.94	20 Kits
MLPE Frame Attachment Kit	242-02151	\$4.68	20 EA



MLPE Rail Attachment Kit includes over-sized Fender Washer, Channel Nut and serrated Flange Bolt.

### Grounding Solutions

Description	SKU	MSRP	QTY*
Ground Lug R, 6-12 AWG	242-02101	\$6.01	20 EA

### Conduit Supports

Description	SKU	MSRP	QTY*
SpeedSeal™ Conduit Mount Kit, 3/4" EMT	242-05164	\$9.10	20 EA
SpeedSeal™ Conduit Mount Kit, 1" EMT	242-05165	\$9.91	20 EA
Conduit Support Assembly, 3/4" EMT	242-02730	\$5.70	20 EA
Conduit Support Assembly, 1" EMT	242-02731	\$6.21	20 EA
Conduit Support Assembly, 3/4" PVC	242-02732	\$5.70	20 EA
Conduit Support Assembly, 1" PVC	242-02733	\$6.21	20 EA
Conduit Support for Tile, 3/4" EMT	242-02104	\$5.70	20 EA
Conduit Support for Tile, 1" EMT	242-02108	\$6.21	20 EA

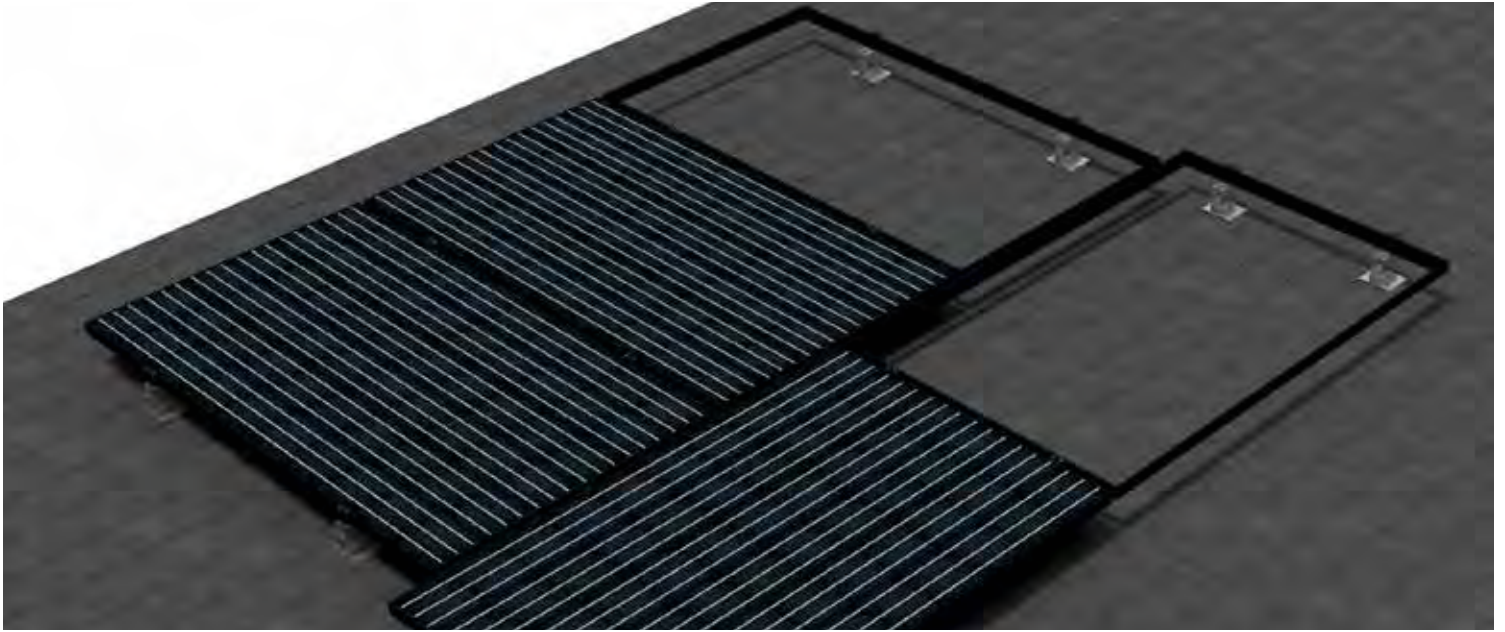

## **SnapNrack MightyMount™** **The Simple but Mighty Mounting System**

MightyMount™ System is a modified railless system designed for a smaller footprint and simple install experience on the roof. MightyMount™ roof attachments are compatible with applications that include composition shingle and trapezoidal metal roofs. The system installs by creating a precise layout for mounts, attaching mounts to the roof, laying down the panels, and securing them utilizing SnapNrack Ultra Rail Mid Clamps and End Clamps. The system includes the familiar SpeedSeal™ Technology with a compressible barrier that secures sealant in place & fills all voids. SnapNrack's tradition of a single tool installation is carried on with the same ½" socket.

- MightyMount™ Comp-S features a small footprint to fit on a single course of shingles.
- MightyMount™ Comp-S is a rafter independent attachment, it eliminates the need to locate or find rafters for pilot holes.
- MightyMount™ Metal-T gives installers the ability to mount on trapezoidal metal roofs like carports.
- MightyMount™ Metal-T tracks are available in two sizes, 10" or 15", both featuring protective gaskets around fasteners for added sealing and utilizing standard EJOT Fasteners for installation.

### **More Info**

[MightyMount™ Product Page](#)

### **Visit Resource Library**

[Download Structural Engineering, Installation Manuals & System Drawings](#)



# MightyMount™ Components

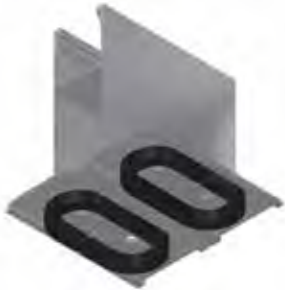

MightyMount™ Comp-S



MightyMount™ Comp-S + Ultra Rail Mid Clamp



MightyMount™ Metal-T Track + Leg

## MightyMount™ Comp-S

Description	SKU	MSRP	QTY*
MightyMount™ Comp-S	242-10026	\$7.50	20 EA
Sealing Washer Wood Screw, #14 x 2¾", SS	242-02175	\$1.00	40 EA
Sealing Wood Screw, #14 x 2¾", ½ HEX, SS, (80 pack)	015-30008	\$60.00	1 EA
Ultra Rail Mid Clamp, Silver	242-02070	\$4.64	20 EA
Ultra Rail Mid Clamp, Black	242-02071	\$4.87	20 EA
Universal End Clamp	242-02215	\$6.28	20 EA
Ultra Rail End Clamp, Silver	242-02072	\$5.77	20 EA
Ultra Rail End Clamp, Black	242-02073	\$6.06	20 EA

## MightyMount™ Metal-T

Description	SKU	MSRP	QTY*
MightyMount™ Metal-T Sealing Track, Short	242-10013	\$5.65	20 EA
MightyMount™ Metal-T Sealing Track, Long	242-10014	\$7.75	20 EA
MightyMount™ Metal-T Leg Assembly, Short	242-10008	\$5.35	20 EA
MightyMount™ Metal-T Leg Assembly, Long	242-10009	\$6.55	20 EA
EJOT JF3-2-5,5X25 E16 Metal Sheet Screw	164-20016	\$1.12	100 EA

 Please refer to the **RL-U Wire Management & Accessories** table on page 6 for all compatible MightyMount Comp-S & MightyMount Metal-T Wire Management Solutions.

\* QTY (Quantity) listed is the standard package and minimum order quantity. SnapRack products are sold through distribution and may be available as individual units.

## Tilt System Roof Attachments

Roof Type	Description	SKU	MSRP	QTY*	
Foam Roof	Select this SKU Ultra Rail Tilt-Mount Kit, 10"	242-10020	\$21.56	20 EA	
	Plus <b>ONE</b> of these SKUs	Ultra Rail Tilt-Mount Kit, 14"	\$22.50	20 EA	
		Ultra Rail Tilt-Mount Kit, 23"	242-10022	\$27.05	10 EA
Metal Roof	Select this SKU Ultra Rail Variable Tilt Hardware Kit for Metal Roof Attachments	242-92116	\$31.67	20 EA	
	Plus <b>ONE</b> of these SKUs	Metal Roof Base	242-02036	\$6.27	20 EA
		Standard Base Seam Clamp	242-05000	\$7.57	20 EA
		Wide Base Seam Clamp	242-05001	\$8.61	20 EA
		Corrugated Straddle Block	232-02421	\$3.00	20 EA
Flat Roof	Select this SKU Ultra Rail Tilt-Mount Kit, 5 1/2"	242-10019	\$20.64	20 EA	
	Plus <b>ONE</b> of these SKUs	Ultra Rail Tilt-Mount Kit, 10"	242-10020	\$23.71	20 EA
		Ultra Rail Tilt-Mount Kit, 14"	242-10021	\$24.75	20 EA
		Ultra Rail Tilt-Mount Kit, 23"	242-10022	\$29.75	10 EA
	Ultra Rail Simple Tilt Front Leg 10° (no base)	242-03217	\$8.00	20 EA	
	Ultra Rail Simple Tilt Back Leg 10° Portrait (no base)	242-03215	\$12.00	20 EA	
	Ultra Rail Simple Tilt Back Leg 10° Landscape (no base)	242-03216	\$10.00	20 EA	



Ultra Rail Tilt-Mount Kits include the new **OmniBase™**, a Standoff Shaft and Ultra Rail Tilt Clamp (Standoff Clamp, L Foot, and Ultra Rail Mounting Hardware).

**Please refer to Ultra Rail Tilt Angle Table (Nominal).**

For Foam Roofs, order **Ultra Rail Tilt-Mount Kit, 10"** for front leg and **Ultra Rail Tilt-Mount Kit, 14"** for rear leg to obtain a desired **low fixed tilt (5° - 14°)**. Order **Ultra Rail Tilt-Mount Kit, 10"** for front leg and **Ultra Rail Tilt-Mount Kit, 23"** for rear leg to obtain a desired **high fixed tilt (15° - 28°)**.

Ultra Rail Variable Tilt Hardware Kit for Metal Roof Attachments includes L Feet, Ultra Rail Mounting Hardware, and miscellaneous hardware to complete kit for front and rear legs. Metal roof attachments (without L Foot) and section of Ultra Rail for rear leg are to be ordered separately.

**Please refer to Ultra Rail Tilt Angle Table (Nominal) to obtain desired tilt angles for 5° - 30° Fixed Tilt Kit Standoffs with Ultra Rail Tilt Clamps.**

**Variable Tilt hardware and Simple Tilt hardware *can be* installed with Standoffs and such, they are not approved in SnapRack Structural Engineering Reports.**

Simple Tilt requires 4ft spacing for portrait modules and 2ft spacing for landscape modules between mounts front to rear, and is only available as a direct mount to roof structure.

Ideal for use with E-Curb (pourable penetration sealant) - available for purchase as special order, Simple Tilt Attachments are for application on flat roofs only.

Note that Simple Tilt SKUs are referred to in Structural Documentation as Tilt Leg Plus.

# Tilt & Standoff Systems



Ultra Rail Tilt-Mount with OmniBase



Ultra Rail OmniBase  
**(SOLD IN KITS)**



Ultra Rail Variable Tilt Hardware Kit for Metal Roof Attachments

## Ultra Rail Tilt Angle Table (Nominal)

5° - 30° Fixed Tilt Kits - Standoffs with Ultra Rail Tilt Clamps

Front to back attachment spacing	Landscape			Portrait		
	5 1/2" & 10" Standoffs	5 1/2" & 14" Standoffs	5 1/2" & 23" Standoffs	5 1/2" & 10" Standoffs	5 1/2" & 14" Standoffs	5 1/2" & 23" Standoffs
16"	16°	28°	N/A	N/A	N/A	N/A
24"	10°	20°	N/A	N/A	N/A	N/A
32"	8°	15°	28°	8°	15°	28°
48"	N/A	N/A	N/A	5°	10°	20°

### Notes:

1. Table is based on 60 cell modules
2. Table assumes mounting zone on portrait modules not exceeding 25% of module length
3. Maximum tilt angle allowed = 30° relative to horizontal
4. All tilt ups must have 5-1/2" Standoff in front

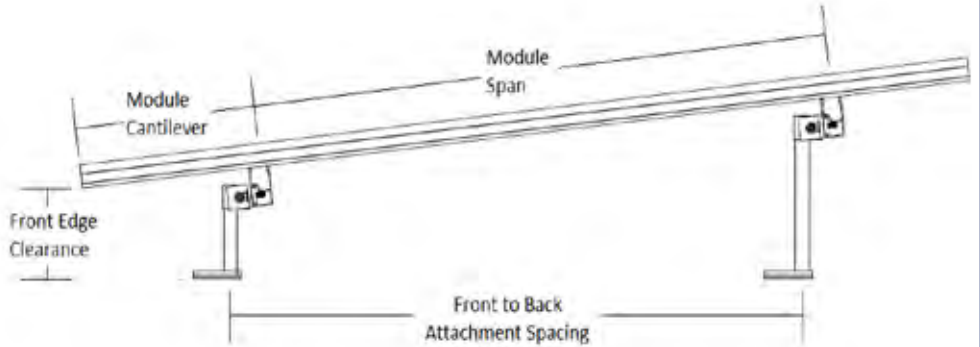

## Ultra Rail Simple Tilt System



Ultra Rail Simple Tilt Portrait

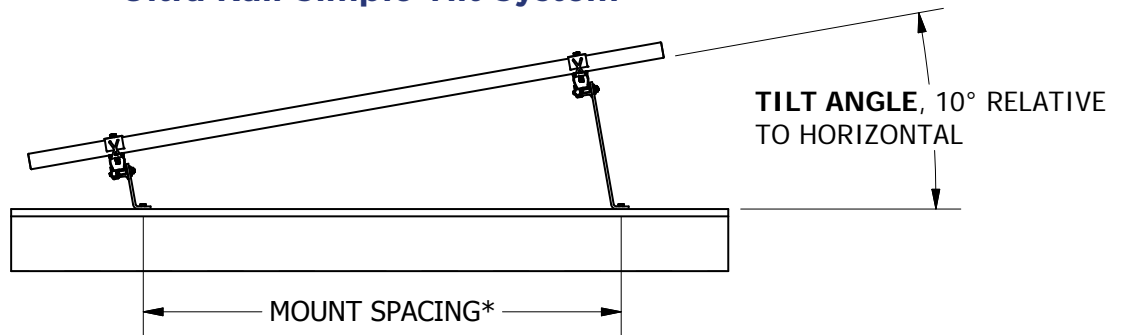

\*4'-0" PORTRAIT  
2'-0" LANDSCAPE

\* QTY (Quantity) listed is the standard package and minimum order quantity. SnapRack products are sold through distribution and may be available as individual units.



## SnapRack & S-5! Metal Roof Solutions

Description	SKU	MSRP	QTY*
All Purpose L Foot ft. S-5! CorruBracket 100T	242-10039	\$17.85	20 EA
All Purpose L Foot ft. S-5! CorruBracket	242-10040	\$20.83	20 EA
All Purpose L Foot ft. S-5! SolarFoot	242-10041	\$16.01	20 EA
Ultra Rail Mounting Clamp ft. S-5! ProteaBracket	242-10042	\$26.03	20 EA
All Purpose L Foot ft. S-5! S-5-N Mini	242-10043	\$17.70	20 EA
All Purpose L Foot ft. S-5! VersaBracket-47	242-10044	\$13.03	20 EA

**NEW**



All Purpose L Foot ft. S-5! CorruBracket



All Purpose L Foot ft. S-5! SolarFoot



UR Mounting Clamp ft. S-5! ProteaBracket



All Purpose L Foot ft. S-5! CorruBracket 100T



All Purpose L Foot ft. S-5! S-5-N Mini



All Purpose L Foot ft. S-5! VersaBracket-47

## Metal Roof Attachments

Description	SKU	MSRP	QTY*
Ultra Rail Metal Roof Base w/ L Foot	242-02158	\$13.89	20 EA
Ultra Rail Standard Base Seam Clamp w/ L Foot & Lock	242-05158	\$13.57	20 EA
Ultra Rail Wide Base Seam Clamp w/ L Foot & Lock	242-05159	\$14.61	20 EA
Ultra Rail All Purpose L Foot (90°), Silver	242-01223	\$6.68	20 EA
Ultra Rail Hanger Bolt Clamp	242-01128	\$6.53	20 EA
Corrugated Straddle Block	232-02421	\$3.00	20 EA
Metal Roof Base	242-02036	\$7.21	20 EA
Standard Base Seam Clamp	242-05000	\$7.57	20 EA
Wide Base Seam Clamp	242-05001	\$8.61	20 EA

# Standoffs & Accessories



OmniShield™



Ultra Rail Flush-Mount  
5 1/2"  
Includes OmniBase™



Ultra Rail OmniBase™  
**(SOLD IN KITS)**



Array Edge Screen  
Fastener



Add-A-Lip Box Frame  
Adapter

## Standoff Mount Roof Attachments

Description	SKU	MSRP	QTY*
Ultra Rail Flush-Mount Kit, 5 1/2"	242-10016	\$16.91	20 EA
Ultra Rail Flush-Mount Kit, 7"	242-10017	\$17.93	20 EA
Ultra Rail Flush-Mount Kit, 8 1/2"	242-10018	\$19.29	20 EA
Standoff Spacer, 1"	242-92081	\$1.66	20 EA
OmniShield™	232-10042	\$26.60	20 EA



Standoff Mount Roof Attachments are sold in kits which include the new **OmniBase™** roof attachment base.

## Standoff Mount Roof Accessories

Description	SKU	MSRP	QTY*
Rubber Rain Collar	232-01000	\$1.18	20 EA
Standoff Flashing, Straight Cone for HD Base, 18" X 18" X 4", Galv	131-01213	\$18.04	12 EA
Standoff Flashing, Verde 1.0STF, Skinny Cone for Tile, 20" x 20" x 3", Dead Soft Alum	175-05001	\$22.48	25 EA
Standoff Flashing, Offset Cone for 1-Hole Base, 18 3/4" x 15" x 4", Galv	131-01216	\$23.20	20 EA
Standoff Flashing, Verde 1.0SSO, Deck Level for 1-Hole Base, 10" x 12" x 1", Galv	175-05005	\$9.11	25 EA

## Array Edge Screen

Description	SKU	MSRP	QTY*
Array Edge Screen, 4" Black (100')	232-03998	\$66.80	1 EA
Array Edge Screen, 6" Black (100')	232-04077	\$112.56	1 EA
Array Edge Screen, 8" Black (100')	232-04076	\$137.85	1 EA
Array Edge Screen Fastener	242-04105	\$2.82	100 EA
Add-A-Lip Box Frame Adapter, Black	242-01101	\$12.11	20 EA

## Misc.

Description	SKU	MSRP	QTY*
Original Channel Nut	232-02005	\$1.13	20 EA
UEC Rail Cutting Tool	232-02284	\$14.25	20 EA
Rail Cover, 48"	232-01033	\$10.07	20 EA

\* **QTY (Quantity)** listed is the standard package and minimum order quantity. SnapRack products are sold through distribution and may be available as individual units.



## **SnapNrack Series 200** **The Adaptable High Quality Solution for Ground Mount Installations**

The Series 200 Ground Mount System is designed to attach easily to a standard 1 ½” galvanized pipe structure using structural pipe fittings. Using a standard three to four-module high assembly, the system is efficient and flexible while optimizing materials and minimizing system footprint. Industry leading installation times are achieved with unique snap-in fasteners.

- Assembles easily using snap-in bonding pipe clamps that connect the rails
- Fully compatible with all SnapNrack module clamps and accessories
- Ground rail channel keeps wires neatly organized providing a clean finished look to every install
- Industry’s largest offering of Wire Management accessories include snap-in Junction Boxes, Universal Wire Clamps, as well as ground rail channel to keep wires neatly organized
- Maximum versatility with the ability to configure easily to desired tilt between 0 and 45 degrees
- Using pipe structural fittings, labor hours to install the system are typically less than required for a more complicated racking system not using standardized components

### **More Info**

[Series 200 Ground Mount Product Page](#)

### **Configuration Tool**

Design a system & download a BOM to quote with the online Configuration Tool

### **Visit Resource Library**

Download Structural Engineering, Installation Manuals & System Drawings

# Series 200 Components



Ground Rail

Series 200 Rail			
Description	SKU	MSRP	QTY*
Ground Rail, 172", Silver (Bundle of 112)	232-02542	\$122.29	112 EA
Ground Rail End Cap	232-01043	\$2.87	20 EA
Ground Rail Splice	242-04009	\$16.88	20 EA



Bonding Pipe Clamp



Double Adjustable Socket Tee, Hollaender

Series 200 Structural Fittings			
Description	SKU	MSRP*	QTY*
Bonding Pipe Clamp for 1 1/2" Pipe	242-09004	\$7.48	20 EA
Single Socket Tee, Hollaender (5EXT-8), 1 1/2", AL-MG	172-05818	\$29.87	1 EA
Single Adjustable Socket Tee, Hollaender (17-8), 1 1/2", AL-MG	172-05803	\$30.87	1 EA
Double Adjustable Socket Tee, Hollaender (19E-8), 1 1/2", AL-MG	172-05804	\$39.93	1 EA
Rectangular Base Flange, Hollaender (46-8), 1 1/2", AL-MG	172-05807	\$28.70	1 EA
Plug End, Hollaender (62-8), 1 1/2" Sched 40, AL	172-05808	\$7.85	1 EA
Adjustable Reducing Elbow/Tee, Hollaender (17-98) 2" x 1 1/2", AL-MG	172-05819	\$47.50	25 EA
Adjustable Reduce Cross Assembly, Hollaender (19-98) 2" x 1 1/2", AL-MG	172-05820	\$69.47	25 EA
Reducing Tee, Hollaender (5-89) 1 1/2" x 2", AL-MG	172-05821	\$38.11	25 EA

\* MSRP from third party manufacturers like Hollaender are subject to change without 30 day notice.

\* QTY (Quantity) listed is the standard package and minimum order quantity. SnapNrack products are sold through distribution and may be available as individual units.

# Place Your Order

Contact your SnapNrack distributor, which can be found at [www.SnapNrack.com/where-to-buy](http://www.SnapNrack.com/where-to-buy), contact us directly at [contact@snapnrack.com](mailto:contact@snapnrack.com), or call us **Toll Free at (877) 732-2860** for technical support.

SnapNrack distributors have trained knowledgeable staff that can provide product design and ordering assistance.

## **MSRP**

Prices published in this document are Manufacturer Suggested Retail Prices (MSRP) and should be used for reference only. Prices are subject to change without notice. The quantity (QTY) shown is based on the standard package and is the recommended order quantity.

## **Warranty**

All SnapNrack products are covered by a **25-year limited warranty**. For complete details please view the online SnapNrack's Manufacturers Limited Product Warranty.

**SnapNrack<sup>®</sup>**

**877-732-2860**

•

**[www.SnapNrack.com](http://www.SnapNrack.com)**

•

**[contact@snapnrack.com](mailto:contact@snapnrack.com)**