

2024 Product Catalog

MSRP Effective July 1, 2024



SnapNrack[®]

Table of Contents

While Supplies Last	2
Pitched Roof	
TopSpeed™ Mounting System <i>Railless Mounting</i>	5
TopSpeed™ Components	6
Wire Management & Grounding	6
RL Universal <i>Railless Mounting</i>	7
RL-U Components	8
SpeedSeal™ Track for RL Universal	8
Wire Management & Grounding	8
Ultra Rail <i>Rail-based Mounting</i>	9
UR-40/60 Rail & Accessories	10
AnchorFoot™ with DeckAnchor™ for Ultra Rail	11
SpeedSeal™ Foot for Ultra Rail	11
SpeedSeal™ DeckFoot for Ultra Rail	11
Umbrella Seal Flashing & L Foot Attachments	11
Module Clamps & Array Skirt	12
Tile Roof Solutions	13
Wire Management Solutions	14
Flat & Metal Roofs	
Ultra Rail Tilt System	15
SnapNrack & S-5! Metal Roof Attachments	17
Metal Roof Attachments	17
Standoff Components & Accessories	18
Ground Mount	
Series 200 <i>Ground Mount</i>	19
Series 200 Rail & Structural Fittings	20

Place Your Order

Contact your SnapNrack distributor, which can be found at www.SnapNrack.com/where-to-buy, contact us directly at contact@snapnrack.com, or call us **Toll Free at (877) 732-2860** for technical support.

MSRP

Prices published in this document are Manufacturer Suggested Retail Prices (MSRP) and should be used for reference only. Prices are subject to change without notice. The quantity (QTY) shown is based on the standard package and is the recommended order quantity.

Warranty

All SnapNrack products are covered by a **25-year limited warranty**. For complete details please view the online SnapNrack's Manufacturers Limited Product Warranty.

WHILE SUPPLIES LAST!

While Supplies Last

Description	SKU	MSRP	QTY*
UR-40 Rail, 172", Silver (Bundle of 144, priced as each)	232-02537	\$59.79	144 EA
UR-60 Rail 172", Silver (Bundle of 120, priced as each)	232-02540	\$78.96	120 EA
Comp Flashing, 9" x 12", Silver Alum (requires Umbrella Lag)	232-01376	\$5.03	20 EA
Comp Flashing, 9" X 12", Black Galvalume (requires Umbrella Lag)	232-01377	\$5.20	20 EA
UR SpeedSeal™ DeckFoot, Silver	242-02173	\$13.50	20 EA
UR SpeedSeal™ DeckFoot, Black	242-02174	\$14.75	20 EA
Corrugated Straddle Block	232-02421	\$3.00	20 EA
Array Edge Screen, 4" Black (100')	232-03998	\$66.80	1 EA
Flash Track Universal Wire Clamp	242-92641	\$6.44	20 EA

SnapNrack®

* QTY (Quantity) listed is the standard package and minimum order quantity. SnapNrack products are sold through distribution and may be available as individual units.

SnapNrack Solar Mounting Solutions



Ultra Rail Roof Mount System | *Rail-based Mounting*

The SnapNrack **Ultra Rail Roof Mount** portfolio satisfies virtually all residential roof types featuring labor saving components like the snap-in mounts and splices along with the open rail channel and accessories to create the industry's leading Wire Management Solutions.

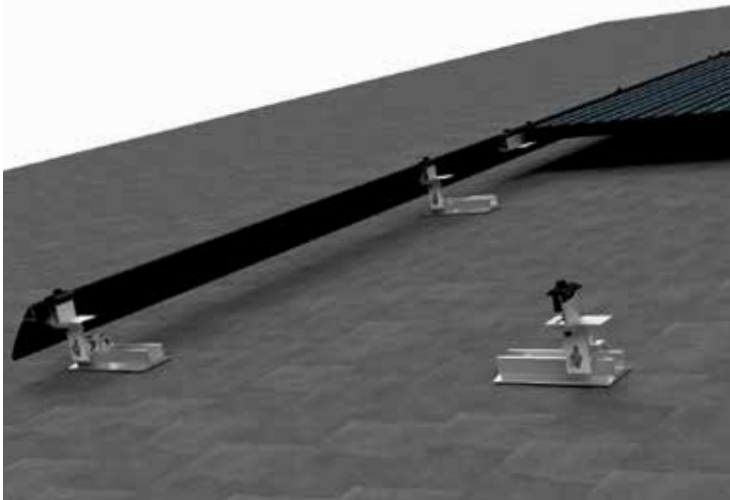

RL Universal Roof Mount System *Railless Mounting*

SnapNrack's **RL Universal System (RL-U)** for composition shingle roofs provides the greatest labor efficiency with an installer focused process allowing the system to be installed by a single person, saving time on the roof. This railless system was designed with an installer-focused approach, featuring Universal Mounts and nothing larger than a module.



TopSpeed™ Roof Mount System *Railless Mounting*

TopSpeed™ Mounting System has completely reinvented the installation process by having the majority of the install performed on the ground. This game changing top-down style mounting system allows installers to get on & off the roof in record time & safely. TopSpeed™ Mounts are attached directly to the modules before the module is brought up on the roof.

Butyl Sealant | Roof Attachment Technology

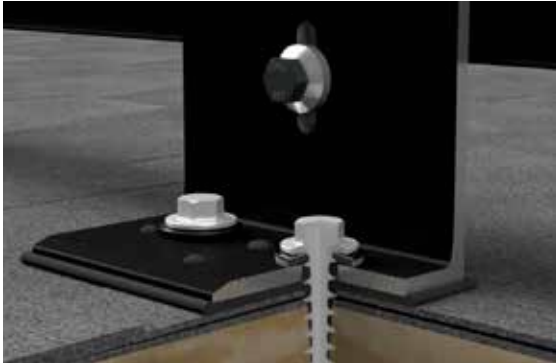

SnapNrack has expanded roof sealant methods with **SpeedSeal+ Technology** - a pre-installed butyl pad for easy peel & stick installation, eliminating disruption to composition shingles. The butyl pad is industry-leading at 0.2" thick, ensuring the roof attachment is fully sealed & watertight. Roof attachments with the butyl remove the need for additional sealant during install, streamlining the process & saving time for installers while ensuring a secure, weatherproof roof attachment.

Integrated Flashing | Roof Attachment Technology

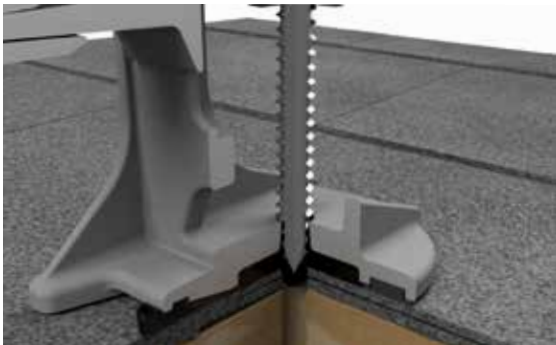

SnapNrack's new **SpeedSeal™ Technology** features an innovative design that incorporates flashing reliability into a single roof attachment by using a patent pending Lag Driven Sealant Technology. The SpeedSeal™ Foot or Track has a sealant cavity with compressible barrier secures sealant in place & fills voids.

Miami-Dade NOA NO: 20-1104.01



Direct to Deck | Roof Attachment Technology

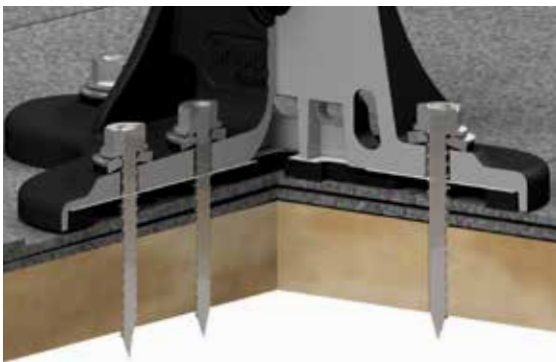

Now **SpeedSeal™ Technology** applies to roof attachments that mount directly to the deck with the **SpeedSeal™ DeckFoot & DeckTrack**. These rafter independent attachments allow for layout adjustability on the roof without the need to locate & attach to rafters. More importantly, installers have the ability to mount on specialty roof structures without standard rafters.

Flashing Based | Roof Attachment Technology

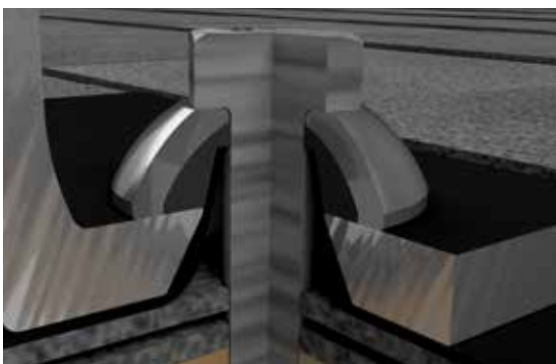

The SnapNrack **Umbrella Seal Technology** is an innovative flashing that uses a fully formed raised cone to prevent any water leakage. When paired with a single lag bolt & our Umbrella Washer, the Ultra Rail L Foot Mount is secured to the roof with the Umbrella Flashing in one step creating a multi-layer waterproof seal.



TOPSPEED

SnapNrack TopSpeed™ Mounting System Time to revolutionize rooftop solar

SnapNrack TopSpeed™ Mounting System is the future of solar racking installation for all installers. This game changing top down style mounting system allows installers to get on and off the roof in record time and safely. TopSpeed™ changes the way solar mounting hardware is installed by simplifying exhaustive layouts, eliminating the guesswork for locating rafters and pilot hole mistakes and saves time by no longer staging material on the roof.

- TopSpeed™ Mount is a preassembled mount that integrates three components into one - includes adjustable Track for North-South flexibility, Wood Fasteners, and Leveling Tower.
- The TopSpeed™ Mounts attach to modules on the ground to speed up the installation process & reduce time on the roof for safety concerns
- TopSpeed™ Clamp enables top down mounting installation with installer safety in mind and supports module overhangs in staggered arrays in place of an additional mount.
- The Universal Skirt features the familiar railless installation by easily locking to bottom row of mounts while ensuring a strong structure for leveling and alignment of first row of modules.

More Info

[TopSpeed™ Product Page](#)

Visit Resource Library

[Download Structural Engineering, Installation Manuals & System Drawings](#)



TopSpeed™ Mount



TopSpeed™ Clamp



Sealing Wood Screw



SpeedSeal™ J Box XL



Smart Clip II



SpeedSeal™ Conduit Mount Kit, 1" EMT

TopSpeed™ Components			
Description	SKU	MSRP	QTY*
TopSpeed™ Mount	242-10005	\$24.68	16 EA
TopSpeed™ Clamp	242-10011	\$6.50	20 EA
Universal Landscape Skirt, 70", Black (Bundle of 72, priced as each)	232-02492	\$45.97	72 EA
Universal Double Portrait Skirt, 83", Black, (Bundle of 72, priced as each)	232-02493	\$52.67	72 EA
Universal Skirt Spacer, 30 mm	232-02532	\$1.00	20 EA
Universal Skirt Spacer, 32 mm	232-02494	\$1.00	20 EA
Universal Skirt Spacer, 35 mm	232-02495	\$1.00	20 EA
Universal Skirt Spacer, 38 mm	232-02496	\$1.00	20 EA
Universal Skirt Spacer, 40 mm	232-02497	\$1.00	20 EA
Sealing Wood Screw, #14 X 2¼", ½" HEX, SS (80 Pack)	015-30008	\$60.00	1 EA

TopSpeed™ Wire Management & Accessories			
Description	SKU	MSRP	QTY*
SnapNRack Grounding Lug	242-92202	\$4.70	20 EA
MLPE Frame Attachment Kit	242-02151	\$4.68	20 EA
Smart Clip II	232-01173	\$0.44	100 EA
Smart Clip XL	232-01176	\$0.61	100 EA
Wire Saver	242-92262	\$2.82	20 EA
SpeedSeal™ Conduit Mount Kit, ¾" EMT	242-05164	\$9.10	20 EA
SpeedSeal™ Conduit Mount Kit, 1" EMT	242-05165	\$9.91	20 EA
Conduit Support Assembly, ¾" EMT	242-02730	\$5.70	20 EA
Conduit Support Assembly, 1" EMT	242-02731	\$6.21	20 EA
Conduit Support Assembly, ¾" PVC	242-02732	\$5.70	20 EA
Conduit Support Assembly, 1" PVC	242-02733	\$6.21	20 EA
FlashBox™	242-10028	\$40.00	1 EA
FlashBox™ Internal Wiring Kit	242-10048	\$40.00	1 EA
SpeedSeal™ J Box XL, Comp Mount	242-92128	\$52.50	1 EA
Junction Box XL with Comp Kit	242-92121	\$54.95	1 EA
Add-A-Lip Box Frame Adapter, Black	242-01101	\$6.05	20 EA

 For additional Universal Skirt SKUs and QTYS, please refer to the **RL-U Skirt Components Table** on page 8.

For additional railless Wire Management Solutions & Accessories, please refer to the **RL-U Wire Management & Accessories Table** on page 8.

* QTY (Quantity) listed is the standard package and minimum order quantity. SnapNRack products are sold through distribution and may be available as individual units.

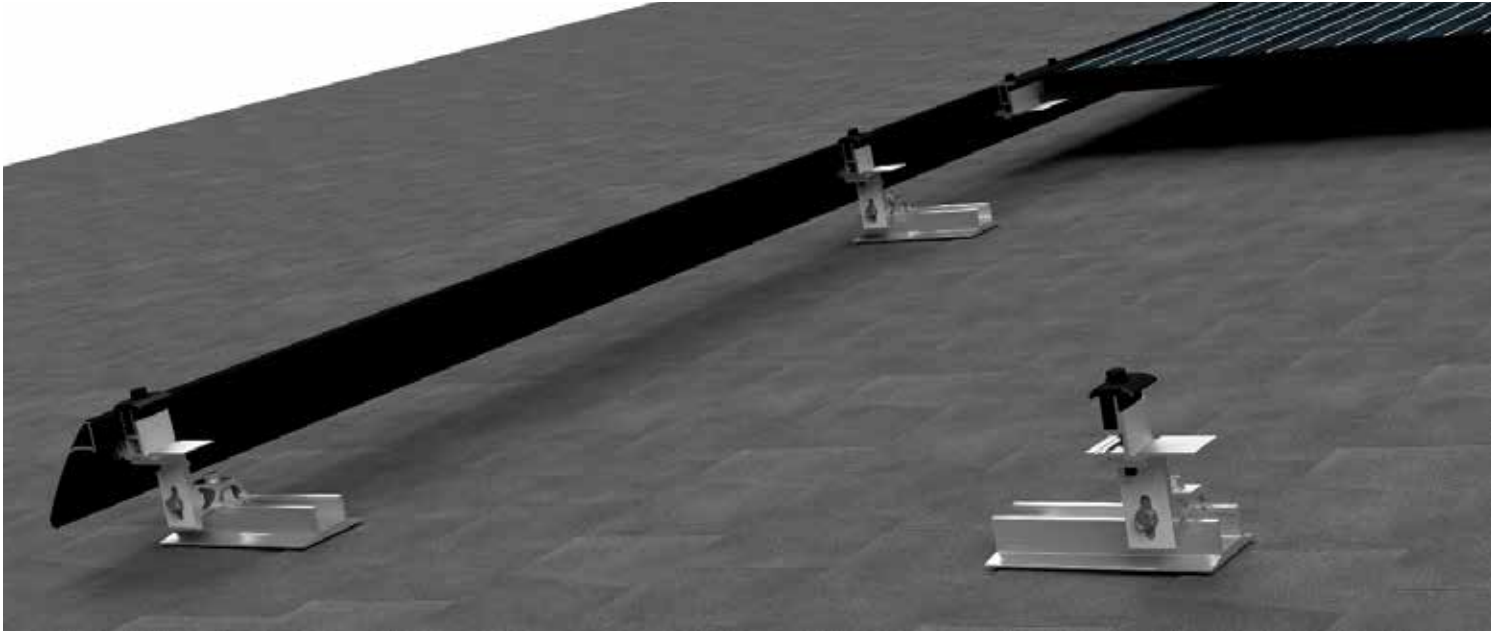

SnapNrack RL Universal **The Fastest Mounting System. Period**

SnapNrack RL Universal Mounting System is designed to provide the fastest, most intuitive install experience on the roof. The direct mount system features four basic components for easy material management. Features incredible flexibility with a single Universal Mount that fits module heights from 30 - 40 mm and the highest spans of any current rail less system. The installer focused process allows the system to be installed by a single person.

- The RL Universal Skirt ensures a strong structure for leveling and alignment of first row of modules.
- Both SpeedSeal™ Technology or Umbrella Seal Technology roof attachments are designed for maximum versatility with 6" of North-South adjustability for all Mounts.
- A single Umbrella Lag screw secures flashing & Flash Track to roof in one complete action.
- A single Mount is used at all locations on array and eliminates Mount/Link interference, bypassing the need for hybrid mounts found in competitive systems.
- The Links clamp onto the top of modules securing them in place while providing row-to-row bonding.

More Info

[RL Universal Product Page](#)

RL Universal Configuration Tool

Design a system & download a BOM to quote with the online Configuration Tool

Visit Resource Library

Download Structural Engineering, Installation Manuals & System Drawings



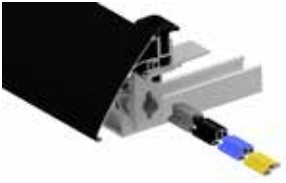

RL-U Skirt with Mount, Flash Track & Spacers
(All Sold Separately)



RL-U SpeedSeal™ Track with Mount
(All Sold Separately)



RL Universal Link

NEW



FlashBox™

NEW

NEW



OmniLug™

NEW



Smart Clip XL



Add-A-Lip Box Frame Adapter

RL-U Skirt Components

Description	SKU	MSRP	QTY*
Universal Landscape Skirt, 70", Black (Bundle of 72, priced as each)	232-02492	\$45.97	72 EA
Universal Double Portrait Skirt, 83", Black, (Bundle of 72, priced as each)	232-02493	\$52.67	72 EA
Universal Skirt Frame Mount	242-10006	\$8.00	20 EA
Universal Skirt Cap	232-10019	\$2.40	20 EA
Universal Skirt Spacer, 30 mm	232-02532	\$1.00	20 EA
Universal Skirt Spacer, 32 mm	232-02494	\$1.00	20 EA
Universal Skirt Spacer, 35 mm	232-02495	\$1.00	20 EA
Universal Skirt Spacer, 38 mm	232-02496	\$1.00	20 EA
Universal Skirt Spacer, 40 mm	232-02497	\$1.00	20 EA

RL-U Mount Components

Description	SKU	MSRP	QTY*
RL Universal Flash Track	232-01371	5.00	20 EA
Comp Flashing, 9" x 12", Black Alum (requires Umbrella Lag)	232-01375	\$6.06	20 EA
Umbrella Lag, 4"	242-92266	\$1.55	20 EA
RL Universal SpeedSeal™ Track	232-01464	\$8.75	20 EA
Sealing Washer Lag, 4 1/2", SS	242-02168	\$1.25	20 EA
Sealing Washer Wood Screw, #14 X 2 3/4", SS	242-02175	\$1.00	40 EA
Sealing Wood Screw, #14 x 2 1/4", 1/2" HEX, SS (80 pack)	015-30008	\$60.00	1 EA
RL Universal Mount	242-02155	\$12.41	20 EA
RL Universal Link	242-02156	\$14.79	20 EA

RL-U Wire Management & Accessories

Description	SKU	MSRP	QTY*
Smart Clip II	232-01173	\$0.44	100 EA
Smart Clip XL	232-01176	\$0.61	100 EA
Wire Saver	242-92262	\$2.82	20 EA
FlashBox™	242-10028	\$40.00	1 EA
FlashBox™ Internal Wiring Kit	242-10048	\$40.00	1 EA
Junction Box XL with Comp Kit	242-92121	\$49.95	1 Kit
OmniLug™	242-10034	\$4.49	20 EA
MLPE Frame Attachment Kit	242-02151	\$4.68	20 EA
Add-A-Lip Box Frame Adapter, Black	242-01101	\$6.05	20 EA

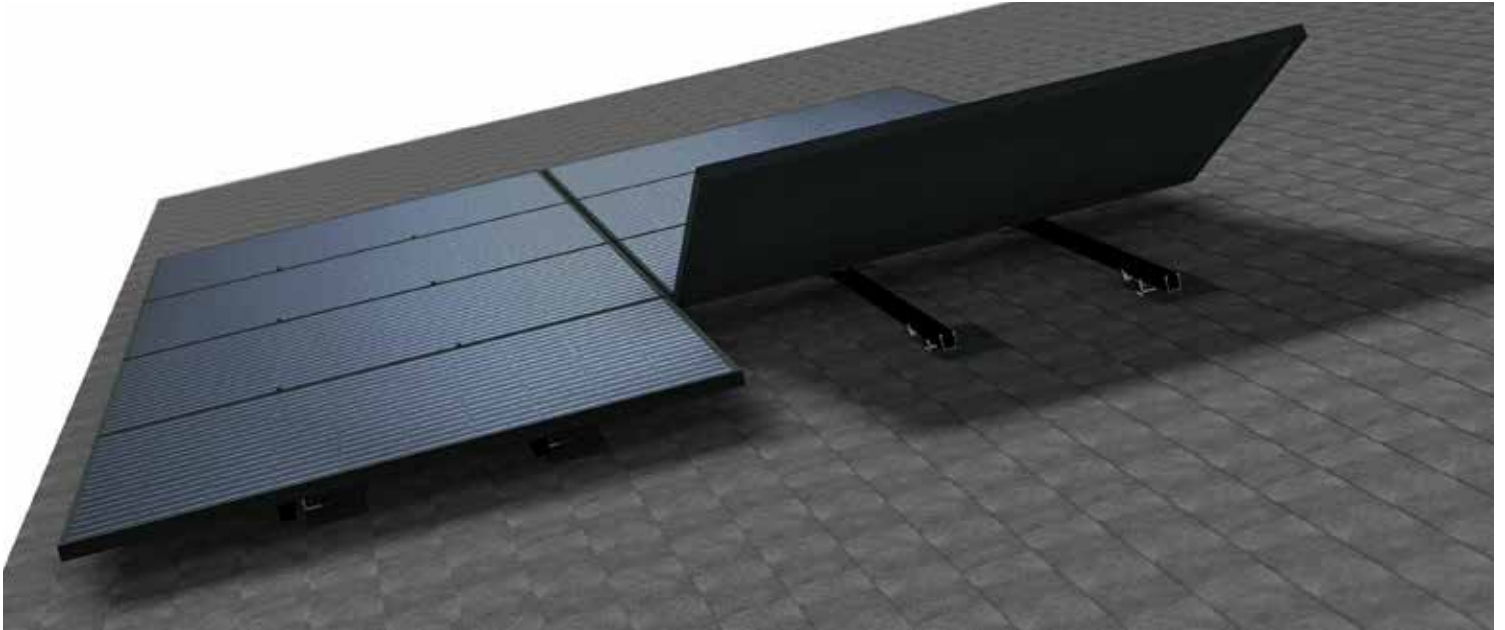

SnapRack Ultra Rail **The Ultimate Value in Rooftop Solar**

Ultra Rail is the ultimate rail solution for mounting solar modules on the roof. The entire system is a snap to install utilizing pre-assembled Ultra Rail Mounts that include snap-in brackets for attaching rail. Snap-in module clamps provide an intuitive install experience installers know and love.

- Industry-leading aesthetics with Universal End Clamps & snap-in End Caps that make the mounting system invisible underneath the array.
- Unparalleled wire management solutions with accessories such as Junction Boxes, Universal Wire Clamps, MLPE Attachment Kits, and Conduit Clamps.
- Low profile rail maintains the open channel with room for running wires resulting in a top quality finished install.
- UR-40 has the largest span capabilities of any light rail solution.
- UR-60 is a heavy duty profile for higher loading conditions.

More Info

[Ultra Rail Product Page](#)

Ultra Rail Configuration Tool

Design a system & download a BOM to quote with the online Configuration Tool

Visit Resource Library

Download Structural Engineering, Installation Manuals & System Drawings

UR-40/60 Rail & Accessories



UR-40 Rail, Black



UR-40 Splice



UR-40 End Cap



UR-60 Rail, Black



UR-60 Splice



UR-60 End Cap

UR-40 Rail			
Description	SKU	MSRP	QTY*
UR-40 Rail, 86", Black (Bundle of 144, priced as each)	232-02551	\$30.46	144 EA
UR-40 Rail, 86", Mill (Bundle of 144, priced as each)	232-02550	\$27.88	144 EA
UR-40 Rail, 172", Black (Bundle of 144, priced as each)	232-02538	\$60.91	144 EA
UR-40 Rail, 172", Mill (Bundle of 144, priced as each)	232-02536	\$55.75	144 EA
UR-60 Rail			
Description	SKU	MSRP	QTY*
UR-60 Rail 172", Black (Bundle of 120, priced as each)	232-02541	\$79.81	120 EA
UR-60 Rail 172", Mill (Bundle of 120, priced as each)	232-02539	\$78.66	120 EA
UR-40 Rail Accessories			
Description	SKU	MSRP	QTY*
UR-40 Splice, Silver	242-01213	\$8.70	20 EA
UR-40 Splice, Black	242-01214	\$9.24	20 EA
UR-40 End Cap	232-02452	\$0.70	20 EA
UR-60 Rail Accessories			
Description	SKU	MSRP	QTY*
UR-60 Splice, Silver	242-01270	\$11.49	20 EA
UR-60 Splice, Black	242-01271	\$11.83	20 EA
UR-60 End Cap	232-02484	\$0.70	20 EA

* QTY (Quantity) listed is the standard package and minimum order quantity. SnapRack products are sold through distribution and may be available as individual units.

Flashing & L Foot Attachments



AnchorFoot™



DeckAnchor™ 2.5



UR SpeedSeal™ Foot, Black



Ultra Rail Umbrella L Foot with Comp Flashing
(Sold Separately)



Ultra Rail Leveling Spacer

Composition Shingle Attachments

Description	SKU	MSRP	QTY*
Ultra Rail AnchorFoot™, Black	242-10038	\$11.50	20 EA
DeckAnchor™ 2.5	242-10035	\$1.80	40 EA
UR SpeedSeal™ Foot, Silver	242-02163	\$9.50	20 EA
UR SpeedSeal™ Foot, Black	242-02167	\$10.50	20 EA
Sealing Washer Lag, 4 1/2", SS	242-02168	\$1.25	20 EA
Sealing Washer Wood Screw, #14 x 2 3/4", SS	242-02175	\$1.00	40 EA
Sealing Wood Screw, #14 x 2 3/4", 1/2 HEX, SS, (80 pack)	015-30008	\$60.00	1 EA
Ultra Rail Umbrella L Foot, Silver	242-01219	\$6.30	20 EA
Ultra Rail Umbrella L Foot, Black	242-01220	\$7.74	20 EA
Comp Flashing, 9" x 12", Black Alum (requires Umbrella Lag)	232-01375	\$5.51	20 EA
Umbrella Lag, 4"	242-92266	\$1.55	20 EA

Ultra Rail Attachment Components

Description	SKU	MSRP	QTY*
Ultra Rail Leveling Spacer, Black	242-05161	\$2.87	20 EA
Ultra Rail Mounting Hardware, Black	242-01230	\$4.24	20 EA
Ultra Rail Mounting Hardware, Silver	242-01229	\$4.08	20 EA
Ultra Rail All Purpose L Foot (90°), Black	242-01239	\$7.04	20 EA
Ultra Rail All Purpose L Foot (90°), Silver	242-01223	\$7.01	20 EA

 **Note that the fasteners are sold separately from the Composition Shingle Roof Attachments listed above. Required fasteners are as follows:**

One (1) Umbrella Lag, 242-92266, is required for each Ultra Rail Umbrella L Foot & Comp Flashing attachment.

One (1) Sealing Washer Lag, 242-02168, is required for each Ultra Rail SpeedSeal™ Foot attachment.

Four (4) Sealing Washer Wood Screws, 242-02175, are required for each Ultra Rail SpeedSeal™ DeckFoot attachment.

Module Clamps & Array Skirt

SnapNrack Module Attachments - Ultra Rail - MightyMount™ - S200

Module Clamps are available for all PV module frame sizes (30-46 mm). **Universal End Clamps** are a unique one-size-fits-all that slips inside the module frame – completely out of sight. The rails are cut flush with the modules and finished with SnapNrack End Caps to create a system with a flush, clean line. All Module Clamps work with Ultra Rail, MightyMount™ and Series 200 Ground Mount. Module Clamps ship pre-assembled, ready to install.



Ultra Rail Mid Clamp,
Black

Mid Clamps			
Description	SKU	MSRP	QTY*
Ultra Rail Mid Clamp, Silver	242-02070	\$4.64	20 EA
Ultra Rail Mid Clamp, Black	242-02071	\$4.87	20 EA
End Clamps			
Description	SKU	MSRP	QTY*
Universal End Clamp	242-02215	\$6.28	20 EA
Ultra Rail End Clamp, Silver	242-02072	\$5.77	20 EA
Ultra Rail End Clamp, Black	242-02073	\$6.06	20 EA



Universal End Clamp



Ultra Rail End Clamp,
Black



Universal Skirt Frame
Mount

Array Skirt			
Description	SKU	MSRP	QTY*
Universal Skirt Frame Mount	242-10006	\$8.00	20 EA
Universal Skirt Cap	232-10019	\$2.40	20 EA
Universal Double Portrait Skirt, 83", Black, (Bundle of 72, priced as each)	232-02493	\$52.67	72 EA



Universal Skirt Cap

* **QTY (Quantity)** listed is the standard package and minimum order quantity. SnapNrack products are sold through distribution and may be available as individual units.

Tile Roof Solutions



Ultra Rail Tile Roof Hook F



Ultra Rail Adjustable Tile Hook



Tile Hook Replacement Flashing, S



Tile Hook Replacement Flashing, W

Tile Roof Hooks			
Description	SKU	MSRP	QTY*
Ultra Rail Tile Roof Hook F	242-01247	\$11.95	20 EA
Ultra Rail Tile Roof Hook WS	242-01248	\$15.62	20 EA
Ultra Rail Adjustable Tile Hook	242-02729	\$16.38	10 EA
Sealing Washer Wood Screw, #14 X 2 ³ / ₄ ", SS	242-02175	\$1.00	40 EA



Ultra Rail Adjustable Tile Hook is the one Tile Hook for all tile roofs with install compatibility on S/W and Flat tile profiles.

Ultra Rail Tile Roof Hook F is for application on flat tile roofs only. Ultra Rail Tile Roof Hook WS is for application on both W & S Shaped tile roofs.

Ultra Rail Tile Hooks ship pre-assembled with the Ultra Rail Mount.

Ultra Rail Adjustable Tile Hook & Ultra Rail Tile Roof Hook WS can be mounted directly to the roof deck with the use of 6 to 8 Sealing Washer Wood Screws (242-02175).

Tile Hook Replacement Flashing			
Description	SKU	MSRP	QTY*
Tile Hook Replacement Flashing, Flat	232-60055	\$15.93	20 EA
Tile Hook Replacement Flashing, S	232-60056	\$15.93	20 EA
Tile Hook Replacement Flashing, W	232-60057	\$15.93	20 EA



Ultra Rail Tile Hook Replacement Flashings are for Tile Hook installations when necessary to replace broken tiles.

Deck Level Flashing for Tile			
Description	SKU	MSRP	QTY*
PS45 Deck Level Flashing Set, (1) 9x9 & (1) 4X13	242-02723	\$7.98	20 Sets
PS45 Deck Level Flashing Set, (1) 5X13 & (1) 4X17	242-02728	\$8.98	20 Sets
Protecto-Tak Spray Adhesive	131-01347	\$32.99	20 EA

* QTY (Quantity) listed is the standard package and minimum order quantity. SnapRack products are sold through distribution and may be available as individual units.

Wire Management Solutions

SnapNrack Wire Management - Ultra Rail - S200

SnapNrack offers the largest set of mounting accessories to enhance the install process. SnapNrack **Wire Management Solutions** comprise a set of dedicated components to reliably and cost-effectively secure PV module and microinverter leads. All components are made of materials which have been selected for their ability to handle high UV exposure and extreme rooftop temperatures common under solar arrays.



Junction Box XL



FlashBox™



OmniLug™



Wire Retention Clip



Universal Wire Clamp

Wire & Electronics Management

Description	SKU	MSRP	QTY*
Junction Box R for Rail	242-01104	\$35.11	1 EA
Junction Box XL for Rail	242-92120	\$47.20	1 EA
Junction Box XL with Comp Kit	242-92121	\$54.95	1 Kit
SpeedSeal™ J Box XL, Comp Mount	242-92128	\$52.50	1 EA
FlashBox™	242-10028	\$40.00	1 EA
FlashBox™ Internal Wiring Kit	242-10048	\$40.00	1 EA
Universal Wire Clamp for Rail	242-02150	\$4.06	20 EA
Snap-in Wire Retention Clip	232-01106	\$0.47	20 EA
Smart Clip II	232-01173	\$0.44	100 EA
Smart Clip XL	232-01176	\$0.61	100 EA
MLPE Frame Attachment Kit	242-02151	\$4.68	20 EA

Grounding Solutions

Description	SKU	MSRP	QTY*
OmniLug™	242-10034	\$4.49	20 EA

 The SnapNrack OmniLug (242-10034) is both a ground lug and a MLPE Rail Attachment assembly for SnapNrack Ultra Rail Systems.

Conduit Supports

Description	SKU	MSRP	QTY*
SpeedSeal™ Conduit Mount Kit, 3/4" EMT	242-05164	\$9.10	20 EA
SpeedSeal™ Conduit Mount Kit, 1" EMT	242-05165	\$9.91	20 EA
Conduit Support Assembly, 3/4" EMT	242-02730	\$5.70	20 EA
Conduit Support Assembly, 1" EMT	242-02731	\$6.21	20 EA
Conduit Support Assembly, 3/4" PVC	242-02732	\$5.70	20 EA
Conduit Support Assembly, 1" PVC	242-02733	\$6.21	20 EA
Conduit Support for Tile, 3/4" EMT	242-02104	\$5.70	20 EA
Conduit Support for Tile, 1" EMT	242-02108	\$6.21	20 EA



Conduit Support
3/4" EMT



Conduit Support -
Tile

Tilt System Roof Attachments

Roof Type	Description	SKU	MSRP	QTY*	
Foam Roof	Select this SKU Ultra Rail Tilt-Mount Kit, 10"	242-10020	\$23.71	20 EA	
	Plus ONE of these SKUs	Ultra Rail Tilt-Mount Kit, 14"	242-10021	\$24.75	20 EA
		Ultra Rail Tilt-Mount Kit, 23"	242-10022	\$29.75	10 EA
	Plus ONE of these SKUs	Metal Roof Base	242-02036	\$6.27	20 EA
		Wide Base Seam Clamp	242-05001	\$8.61	20 EA
Flat Roof	Select this SKU Ultra Rail Tilt-Mount Kit, 5½"	242-10019	\$20.64	20 EA	
	Plus ONE of these SKUs	Ultra Rail Tilt-Mount Kit, 10"	242-10020	\$23.71	20 EA
		Ultra Rail Tilt-Mount Kit, 14"	242-10021	\$24.75	20 EA
		Ultra Rail Tilt-Mount Kit, 23"	242-10022	\$29.75	10 EA
	Ultra Rail Simple Tilt Front Leg 10°	242-03217	\$8.00	20 EA	
	Ultra Rail Simple Tilt Back Leg 10° Portrait	242-03215	\$12.00	20 EA	
	Ultra Rail Simple Tilt Back Leg 10° Landscape	242-03216	\$10.00	20 EA	
	Ultra Rail Simple Tilt Front Leg 5°	242-10060	\$8.00	20 EA	
Ultra Rail Simple Tilt Front Leg 5° Portrait	242-10062	\$12.00	20 EA		
Ultra Rail Simple Tilt Front Leg 5° Landscape	242-10061	\$10.00	20 EA		

 Ultra Rail Tilt-Mount Kits include include the new **OmniBase™**, a Standoff Shaft and Ultra Rail Tilt Clamp (Standoff Clamp, L Foot, and Ultra Rail Mounting Hardware).

Please refer to Ultra Rail Tilt Angle Table (Nominal).

For Foam Roofs, order **Ultra Rail Tilt-Mount Kit, 10"** for front leg and **Ultra Rail Tilt-Mount Kit, 14"** for rear leg to obtain a desired **low fixed tilt (5° - 14°)**. Order **Ultra Rail Tilt-Mount Kit, 10"** for front leg and **Ultra Rail Tilt-Mount Kit, 23"** for rear leg to obtain a desired **high fixed tilt (15° - 28°)**.

Ultra Rail Variable Tilt Hardware Kit for Metal Roof Attachments includes L Feet, Ultra Rail Mounting Hardware, and miscellaneous hardware to complete kit for front and rear legs. Metal roof attachments (without L Foot) and section of Ultra Rail for rear leg are to be ordered separately.

Please refer to Ultra Rail Tilt Angle Table (Nominal) to obtain desired tilt angles for 5° - 30° Fixed Tilt Kit Standoffs with Ultra Rail Tilt Clamps.

Variable Tilt hardware and Simple Tilt hardware *can be* installed with Standoffs and such, they are not approved in SnapNrack Structural Engineering Reports.

Simple Tilt requires 4ft spacing for portrait modules and 2ft spacing for landscape modules between mounts front to rear, and is only available as a direct mount to roof structure.

Ideal for use with E-Curb (pourable penetration sealant) - available for purchase as special order, Simple Tilt Attachments are for application on flat roofs only.

Note that Simple Tilt SKUs are referred to in Structural Documentation as Tilt Leg Plus.

Tilt & Standoff Systems



Ultra Rail Tilt-Mount with OmniBase™



Ultra Rail OmniBase
(SOLD IN KITS)



Ultra Rail Variable Tilt Hardware Kit for Metal Roof Attachments

Ultra Rail Tilt Angle Table (Nominal)

5° - 30° Fixed Tilt Kits - Standoffs with Ultra Rail Tilt Clamps

Front to back attachment spacing	Landscape			Portrait		
	5 ½" & 10" Standoffs	5 ½" & 14" Standoffs	5 ½" & 23" Standoffs	5 ½" & 10" Standoffs	5 ½" & 14" Standoffs	5 ½" & 23" Standoffs
16"	16°	28°	N/A	N/A	N/A	N/A
24"	10°	20°	N/A	N/A	N/A	N/A
32"	8°	15°	28°	8°	15°	28°
48"	N/A	N/A	N/A	5°	10°	20°

Notes:

1. Table is based on 60 cell modules
2. Table assumes mounting zone on portrait modules not exceeding 25% of module length
3. Maximum tilt angle allowed = 30° relative to horizontal
4. All tilt ups must have 5-1/2" Standoff in front

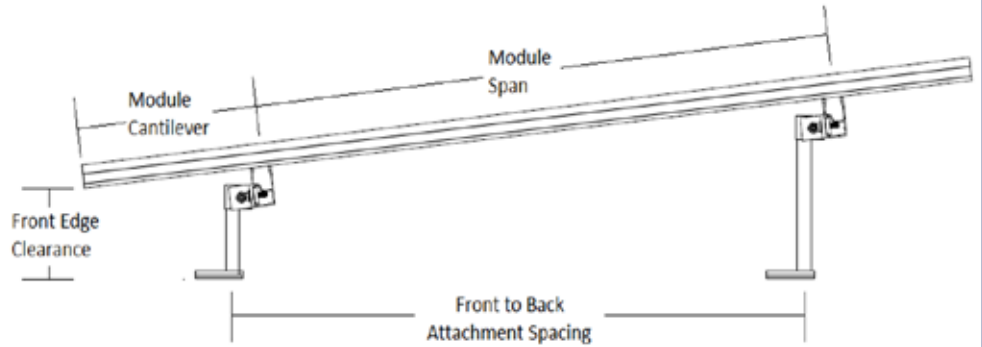

Ultra Rail Simple Tilt System



Ultra Rail Simple Tilt Portrait

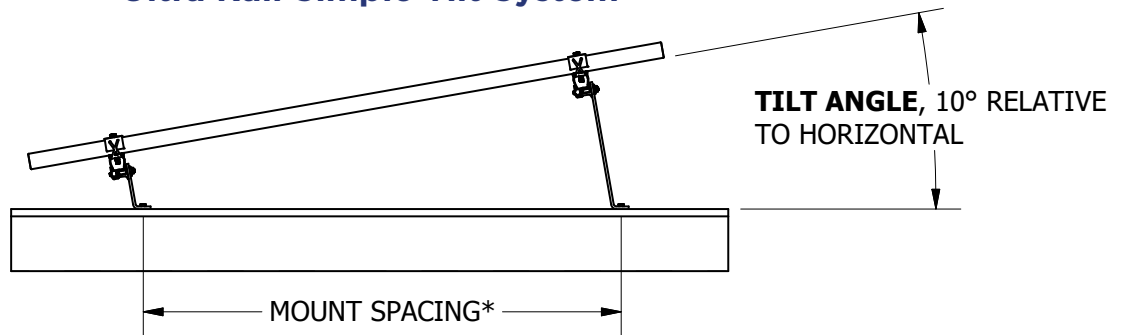

*4'-0" PORTRAIT
2'-0" LANDSCAPE

* QTY (Quantity) listed is the standard package and minimum order quantity. SnapRack products are sold through distribution and may be available as individual units.



SnapNrack & S-5! Metal Roof Solutions			
Description	SKU	MSRP	QTY*
All Purpose L Foot ft. S-5! CorruBracket 100T	242-10039	\$17.85	20 EA
All Purpose L Foot ft. S-5! CorruBracket	242-10040	\$20.83	20 EA
All Purpose L Foot ft. S-5! SolarFoot	242-10041	\$16.01	20 EA
Ultra Rail Mounting Clamp ft. S-5! ProteaBracket	242-10042	\$26.03	20 EA
All Purpose L Foot ft. S-5! S-5-N Mini	242-10043	\$17.70	20 EA
All Purpose L Foot ft. S-5! VersaBracket-47	242-10044	\$13.03	20 EA

 Please note that **SKU 242-10039 & SKU 242-10042** ship with (4) S-5! 1/4" x 1" metal-to-metal self-piercing screws. Additional screw for other applications should be purchased separately via your distributor.



All Purpose L Foot ft. S-5! CorruBracket



All Purpose L Foot ft. S-5! SolarFoot



UR Mounting Clamp ft. S-5! ProteaBracket



All Purpose L Foot ft. S-5! CorruBracket 100T



All Purpose L Foot ft. S-5! S-5-N Mini



All Purpose L Foot ft. S-5! VersaBracket-47

Metal Roof Attachments			
Description	SKU	MSRP	QTY*
Ultra Rail Metal Roof Base w/ L Foot	242-02158	\$13.89	20 EA
Ultra Rail Wide Base Seam Clamp w/ L Foot & Lock	242-05159	\$14.61	20 EA
Ultra Rail All Purpose L Foot (90°), Silver	242-01223	\$6.68	20 EA
Ultra Rail Hanger Bolt Clamp	242-01128	\$6.53	20 EA
Metal Roof Base	242-02036	\$7.21	20 EA
Wide Base Seam Clamp	242-05001	\$8.61	20 EA



OmniShield™



Ultra Rail Flush-Mount
5 1/2"
Includes OmniBase™



Array Edge Screen
Fastener

Standoff Mount Roof Attachments

Description	SKU	MSRP	QTY*
Ultra Rail Flush-Mount Kit, 5 1/2"	242-10016	\$16.91	20 EA
Ultra Rail Flush-Mount Kit, 7"	242-10017	\$17.93	20 EA
Ultra Rail Flush-Mount Kit, 8 1/2"	242-10018	\$19.29	20 EA
OmniShield™	232-10042	\$26.60	20 EA



Standoff Mount Roof Attachments are sold in kits which include the new **OmniBase™** roof attachment base.

Standoff Mount Roof Accessories

Description	SKU	MSRP	QTY*
Rubber Rain Collar	232-01000	\$1.18	20 EA
Standoff Flashing, Verde 1.0STF, Skinny Cone for Tile, 20" x 20" x 3", Dead Soft Alum	175-05001	\$22.48	25 EA
Standoff Flashing, Verde 1.0SSO, Deck Level for 1-Hole Base, 10" x 12" x 1", Galv	175-05005	\$9.11	25 EA

Array Edge Screen

Description	SKU	MSRP	QTY*
Array Edge Screen, 6" Black (100')	232-04077	\$112.56	1 EA
Array Edge Screen, 8" Black (100')	232-04076	\$137.85	1 EA
Array Edge Screen Fastener	242-04105	\$2.82	100 EA
Add-A-Lip Box Frame Adapter, Black	242-01101	\$6.05	20 EA

* QTY (Quantity) listed is the standard package and minimum order quantity. SnapRack products are sold through distribution and may be available as individual units.

SnapRack Series 200 Ground Mount - The Adaptable High Quality Solution

Series 200 Ground Mount System is efficient & flexible while optimizing materials and minimizing footprint. The system is designed to attach easily to a standard 1 ½” galvanized pipe structure using snap-in features and structural pipe fittings. Newly improved engineering allows for up to five-module high assembly & a foundation option utilizing ground screws via 2” schedule pipe.



Series 200 Rail

Description	SKU	MSRP	QTY*
Ground Rail, 172”, Mill (Bundle of 112)	232-02542	\$122.29	112 EA
Ground Rail End Cap	232-01043	\$2.87	20 EA
Ground Rail Splice	242-04009	\$16.88	20 EA

Series 200 Structural Fittings

Description	SKU	MSRP*	QTY*
Bonding Pipe Clamp for 1 ½” Pipe	242-09004	\$7.48	20 EA
Single Socket Tee, Hollaender (5EXT-8), 1 ½”, AL-MG	172-05818	\$29.87	1 EA
Single Adjustable Socket Tee, Hollaender (17-8), 1 ½”, AL-MG	172-05803	\$30.87	1 EA
Double Adjustable Socket Tee, Hollaender (19E-8), 1 ½”, AL-MG	172-05804	\$39.93	1 EA
Rectangular Base Flange, Hollaender (47-9) 2”, AL-MG	172-05822	\$52.77	1 EA
Rectangular Base Flange, Hollaender (46-8), 1 ½”, AL-MG	172-05807	\$28.70	1 EA
Plug End, Hollaender (62-8), 1 ½” Sched 40, AL	172-05808	\$7.85	1 EA
Adjustable Reducing Elbow/Tee, Hollaender (17-98) 2” x 1 ½”, AL-MG	172-05819	\$47.50	25 EA
Adjustable Reduce Cross Assembly, Hollaender (19-98) 2”x 1 ½”, AL-MG	172-05820	\$69.47	25 EA
Reducing Tee, Hollaender (5-89) 1 ½” x 2”, AL-MG	172-05821	\$38.11	25 EA



Ground Rail



Bonding Pipe Clamp



Double Adjustable
Socket Tee, Hollaender

* MSRP from third party manufacturers like Hollaender are subject to change without 30 day notice.

* QTY (Quantity) listed is the standard package and minimum order quantity. SnapRack products are sold through distribution and may be available as individual units.