

2025 Product Catalog

MSRP Effective Jan. 1, 2025



SnapNrack®

Table of Contents

Domestic Content Product	2
Pitched Roof	
TopSpeed® Universal Mounting System <i>Railless Mounting</i>	5
TopSpeed Universal Components	6
Wire Management & Grounding	6
TopSpeed® <i>Original</i> <i>Railless Mounting</i>	7
TopSpeed Original Components	8
TopSpeed Components	8
Wire Management & Grounding	8
Ultra Rail <i>Rail-based Mounting</i>	9
UR-45 Rail & Accessories	10
UltraFoot™ with DeckAnchor™ for Ultra Rail	11
SpeedSeal™ Foot for Ultra Rail	11
Umbrella Seal Flashing & L Foot Attachments	11
Module Clamps & SkirtRail	12
Tile Roof Solutions	13
Wire Management Solutions	14
Flat & Metal Roofs	
Ultra Rail Tilt System	15
SnapNrack & S-5! Metal Roof Attachments	17
Metal Roof Attachments	17
Standoff Components & Accessories	18
Ground Mount	
Series 200 <i>Ground Mount</i>	19
Series 200 Rail & Structural Fittings	20
While Supplies Last	21
While Supplies Last - <i>updated quarterly</i>	21

SnapNrack Domestic Content

NEW

SnapNrack®

NEW

Domestic Content - Rail

Description	SKU	MSRP	QTY*
UR-45 Rail, 172", Mill (USA) (Bundle of 144, priced as each)	232-10095-USA	\$55.75	144 EA
UR-45 Rail, 172", Black (USA) (Bundle of 144, priced as each)	232-10096-USA	\$78.91	144 EA
Ground Rail, 172", Mill (USA) (Bundle of 112, priced as each)	232-02542-USA	\$122.29	112 EA
Universal Landscape SkirtRail, 70", Black (USA) (Bundles of 72, priced as each)	232-02492-USA	\$66.99	72 EA
Universal Double Portrait SkirtRail, 83", Black (USA) (Bundles of 72, priced as each)	232-02493-USA	\$75.99	72 EA

Domestic Content - Fasteners

Ultra Rail Umbrella L Foot, Black (USA)	242-01220-USA	\$10.99	20 EA
UltraFoot, Rafter, Black (USA)	242-10056-USA	\$10.99	20 EA
UltraFoot, Deck, Black (USA)	242-10057-USA	\$13.99	20 EA
UltraFoot, Anchor, Black (USA)	242-10058-USA	\$13.99	20 EA
Ultra Rail Mid Clamp, Black (USA)	242-02071-USA	\$7.89	20 EA
Ultra Rail End Clamp, Black (USA)	242-02073-USA	\$7.94	20 EA
Universal End Clamp (USA)	242-02215-USA	\$7.94	20 EA
UR-40 & UR-45 Splice, Silver (USA)	242-01213-USA	\$12.90	20 EA
UR-40 & UR-45 Splice, Black (USA)	242-01214-USA	\$14.90	20 EA
Ultra Rail Adjustable Tile Hook (USA)	242-02729-USA	\$25.09	10 EA
Ultra Rail Mounting Clamp feat. S-5! ProteaBracket (USA)	242-10042-USA	\$26.03	20 EA
Ultra Rail Simple Tilt Front Leg 5° (USA)	242-10060-USA	\$12.63	20 EA
Ultra Rail Simple Tilt Back Leg 5° Landscape (USA)	242-10061-USA	\$16.15	20 EA
Ultra Rail Simple Tilt Back Leg 5° Portrait (USA)	242-10062-USA	\$19.15	20 EA
Universal SkirtRail Spacer, 30MM (USA)	232-02532-USA	\$1.35	20 EA
Universal SkirtRail Spacer, 32MM (USA)	232-02494-USA	\$1.35	20 EA
Universal SkirtRail Spacer, 35MM (USA)	232-02495-USA	\$1.35	20 EA
Universal SkirtRail Spacer, 38MM (USA)	232-02496-USA	\$1.35	20 EA
Universal SkirtRail Spacer, 40MM (USA)	232-02497-USA	\$1.35	20 EA
AlphaTrack™ (USA)	242-10063-USA	\$10.97	20 EA
DeltaTrack™ (USA)	242-10064-USA	\$10.97	20 EA
TopSpeed® Universal Mount (USA)	242-02155-USA	\$15.89	20 EA
Universal Link (USA)	242-02156-USA	\$18.99	20 EA

* QTY (Quantity) listed is the standard package and minimum order quantity. SnapNrack products are sold through distribution and may be available as individual units.

SnapNrack Solar Mounting Solutions



Ultra Rail Roof Mount System | *Rail-based Mounting*

The SnapNrack **Ultra Rail Roof Mount** portfolio satisfies virtually all residential roof types featuring labor saving components like the snap-in mounts and splices along with the open rail channel and accessories to create the industry's leading Wire Management Solutions.

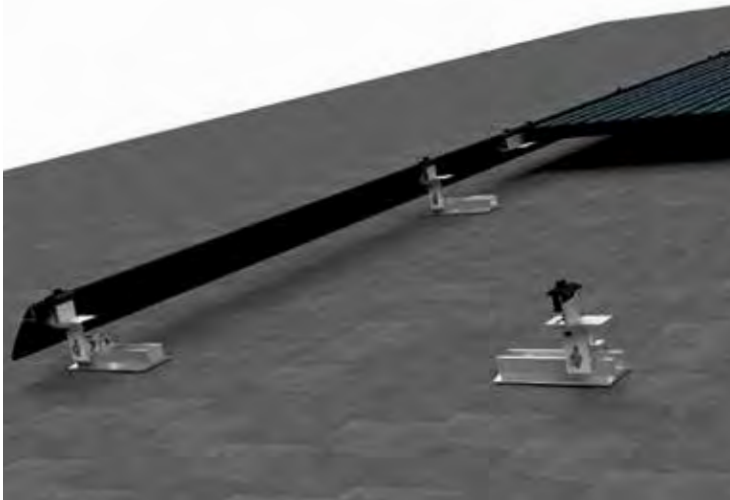

TopSpeed® Universal Roof Mount System
Railless Mounting



TopSpeed® Original Roof Mount System
Railless Mounting

SnapNrack's **TopSpeed Universal System** for composition shingle roofs provides the greatest labor efficiency with an installer focused process allowing the system to be installed by a single person, saving time on the roof. This railless system was designed with an installer-focused approach, featuring Universal Mounts and nothing larger than a module.

TopSpeed® Original Mounting System has completely reinvented the installation process by having the majority of the install performed on the ground. This game changing top-down style mounting system allows installers to get on & off the roof in record time & safely. TopSpeed Original Mounts are attached directly to the modules before the module is brought up on the roof.

SpeedSeal™+ Technology Sealant | Roof Sealing Technology



SnapNrack has expanded roof sealant methods with **SpeedSeal™+ Technology** - a pre-installed butyl pad for easy peel & stick installation, eliminating disruption to composition shingles. The butyl pad is industry-leading at 0.2" thick, ensuring the roof attachment is fully sealed & watertight. Roof attachments with the butyl remove the need for additional sealant during install, streamlining the process & saving time for installers while ensuring a secure, weatherproof roof attachment.

SpeedSeal™ Technology | Roof Sealing Technology

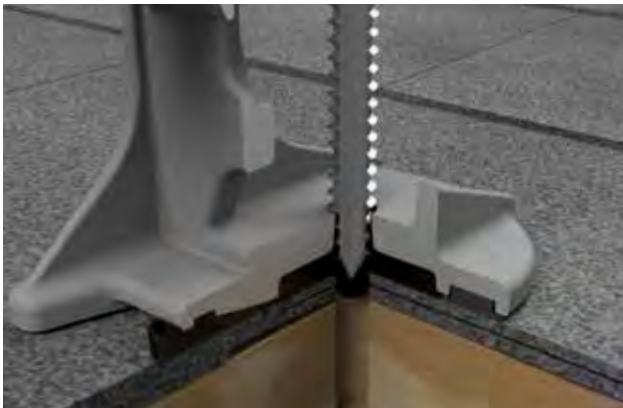

SnapNrack's **SpeedSeal™ Technology** features an innovative design that incorporates flashing reliability into a single roof attachment by using a patented Lag Driven Sealant Technology. The SpeedSeal™ Foot or Track has a sealant cavity with compressible barrier secures sealant in place & fills voids.

Miami-Dade NOA NO: 20-1104.01



Umbrella Seal Technology Based | Roof Sealing Technology

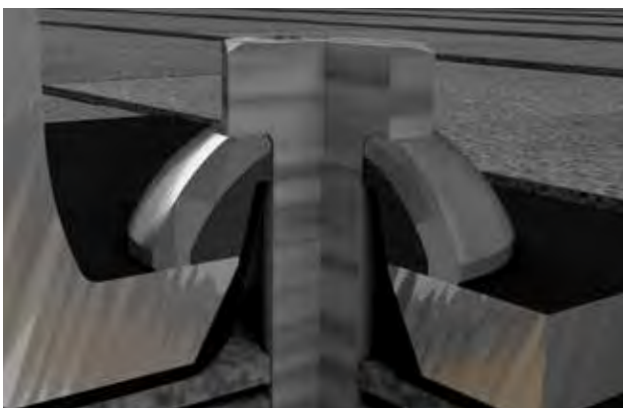

The SnapNrack **Umbrella Seal Technology** is an innovative flashing that uses a fully formed raised cone to prevent any water leakage. When paired with a single lag bolt & our Umbrella Washer, the Ultra Rail L Foot Mount is secured to the roof with the Umbrella Flashing in one step creating a multi-layer waterproof seal.

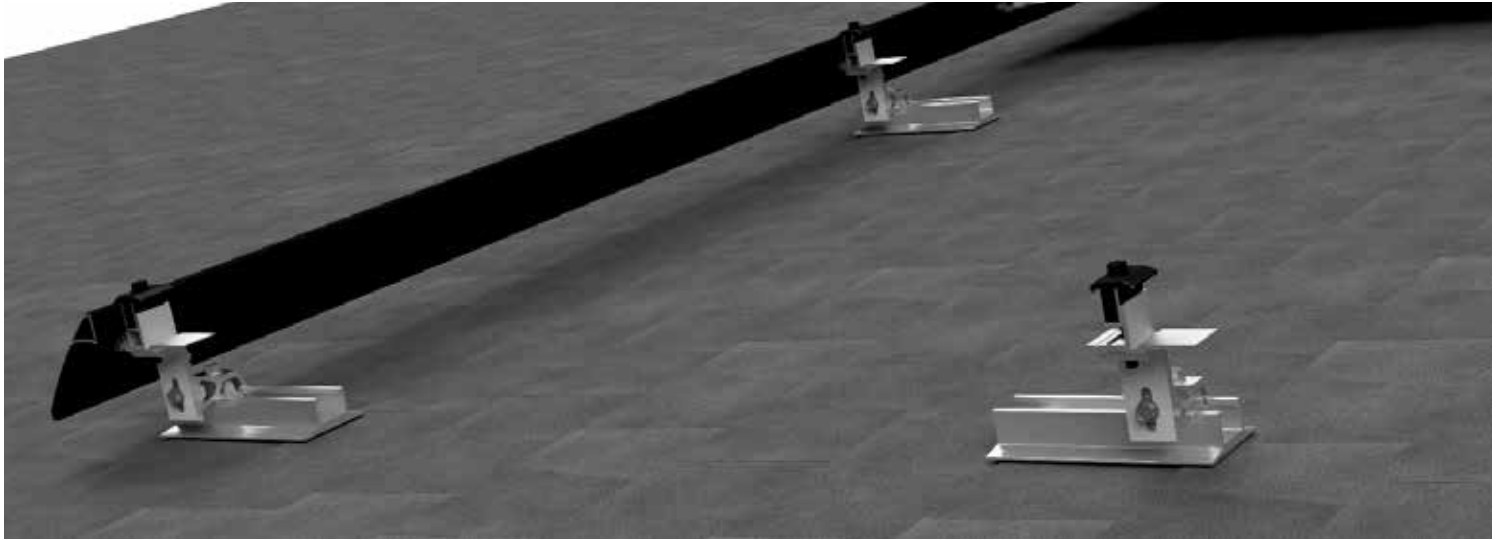

SnapNrack TopSpeed® Universal The Fastest Mounting System. Period

SnapNrack TopSpeed Universal Mounting System is designed to provide the fastest, most intuitive install experience on the roof. The direct mount system features four basic components for easy material management. Features incredible flexibility with a single Universal Mount that fits module heights from 30 - 40 mm and the highest spans of any current rail less system. The installer focused process allows the system to be installed by a single person.

- The Universal SkirtRail ensures a strong structure for leveling and alignment of first row of modules.
- SpeedSeal™+, SpeedSeal™ or Umbrella Seal Technologies roof attachments are designed for maximum versatility with 6" of North-South adjustability for all Mounts.
- A single Umbrella Lag screw secures flashing & Flash Track to roof in one complete action.
- A single Mount is used at all locations on array and eliminates Mount/Link interference, bypassing the need for hybrid mounts found in competitive systems.
- The Links clamp onto the top of modules securing them in place while providing row-to-row bonding.

TOPSPEED®
UNIVERSAL

More Info

[TopSpeed Universal Product Page](#)

TopSpeed Universal Configuration Tool

Design a system & download a BOM to quote with the online Configuration Tool

Visit Resource Library

Download Structural Engineering, Installation Manuals & System Drawings

TopSpeed Universal Components



SkirtRail with Mount,
Flash Track & Spacers
(All Sold Separately)

NEW



DeltaTrack™



Flash Track w/Comp
Flashing & Umbrella Lag
(All Sold Separately)

NEW



Universal Link



FlashBox™



OmniLug™

SkirtRail Components

Description	SKU	MSRP	QTY*
Universal Landscape SkirtRail, 70", Black (Bundles of 72, priced as each)	232-02492	\$45.97	72 EA
Universal Double Portrait SkirtRail, 83", Black, (Bundle of 72, priced as each)	232-02493	\$52.67	72 EA
Universal SkirtRail Frame Mount	242-10006	\$8.00	20 EA
Universal SkirtRail Cap	232-10019	\$2.40	20 EA
Universal SkirtRail Spacer, 30 mm	232-02532	\$1.00	20 EA
Universal SkirtRail Spacer, 32 mm	232-02494	\$1.00	20 EA
Universal SkirtRail Spacer, 35 mm	232-02495	\$1.00	20 EA
Universal SkirtRail Spacer, 38 mm	232-02496	\$1.00	20 EA
Universal SkirtRail Spacer, 40 mm	232-02497	\$1.00	20 EA

TopSpeed Universal Mount Components

Description	SKU	MSRP	QTY*
DeltaTrack™	242-10064	\$6.60	20 EA
Flash Track	232-01371	\$5.00	20 EA
Comp Flashing, 9" x 12", Black Alum (requires Umbrella Lag)	232-01375	\$6.06	20 EA
Umbrella Lag, 4"	242-92266	\$1.55	20 EA
Sealing Washer Lag, 4 1/2", SS	242-02168	\$1.25	20 EA
TopSpeed Universal Mount	242-02155	\$12.41	20 EA
Universal Link	242-02156	\$14.79	20 EA

Rainless Wire Management & Accessories

Description	SKU	MSRP	QTY*
Smart Clip II	232-01173	\$0.44	100 EA
Smart Clip XL	232-01176	\$0.61	100 EA
Wire Saver	242-92262	\$2.82	20 EA
FlashBox™	242-10028	\$40.00	1 EA
FlashBox™ Internal Wiring Kit	242-10048	\$50.00	20 EA
OmniLug™	242-10034	\$4.49	20 EA
MLPE Frame Attachment Kit	242-02151	\$4.68	20 EA
Add-A-Lip Box Frame Adapter, Black	242-01101	\$6.05	20 EA



For additional railless Wire Management Solutions & Accessories, please refer to the **Rainless Wire Management & Accessories Table** on page 8.



Smart Clip XL

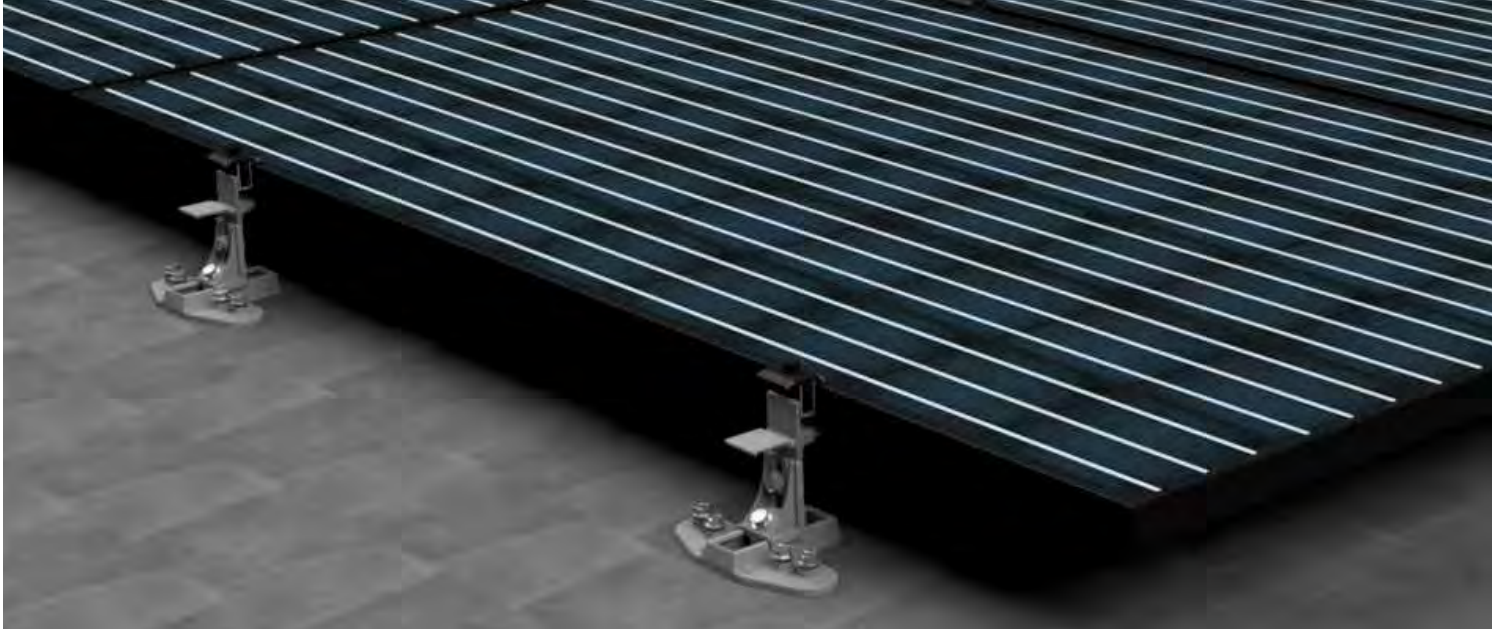

TOPSPEED®

SnapNrack TopSpeed® *Original* Mounting System Time to revolutionize rooftop solar

SnapNrack TopSpeed *Original* Mounting System is a top down style railless mounting system that allows installers to get on and off the roof in record time and safely. TopSpeed changes the way solar mounting hardware is installed by simplifying exhaustive layouts, eliminating the guesswork for locating rafters and pilot hole mistakes and saves time by no longer staging material on the roof.

- TopSpeed *Original* Mount is a preassembled mount that integrates three components into one - includes adjustable Track for North-South flexibility, Wood Fasteners, and Leveling Tower.
- The TopSpeed Mounts attach to modules on the ground to speed up the installation process & reduce time on the roof for safety concerns
- TopSpeed Clamp enables top down mounting installation with installer safety in mind and supports module overhangs in staggered arrays in place of an additional mount.
- The Universal SkirtRail features the familiar railless installation by easily locking to bottom row of mounts while ensuring a strong structure for leveling and alignment of first row of modules.

More Info

[TopSpeed Product Page](#)

Visit Resource Library

[Download Structural Engineering, Installation Manuals & System Drawings](#)

TopSpeed® Original Components



TopSpeed™ Original Mount



TopSpeed™ Clamp



Sealing Wood Screw



SpeedSeal™ J Box XL



Universal Conduit Mount, Leveling



Universal Conduit Mount, Simple



Smart Clip II



Add-A-Lip Box Frame Adapter

TopSpeed Original Components

Description	SKU	MSRP	QTY*
TopSpeed™ Original Mount	242-10005	\$24.68	16 EA
TopSpeed™ Clamp	242-10011	\$6.50	20 EA
Universal Landscape SkirtRail, 70", Black (Bundle of 72, priced as each)	232-02492	\$45.97	72 EA
Universal Double Portrait SkirtRail, 83", Black, (Bundle of 72, priced as each)	232-02493	\$52.67	72 EA
Universal SkirtRail Spacer, 30 mm	232-02532	\$1.00	20 EA
Universal SkirtRail Spacer, 32 mm	232-02494	\$1.00	20 EA
Universal SkirtRail Spacer, 35 mm	232-02495	\$1.00	20 EA
Universal SkirtRail Spacer, 38 mm	232-02496	\$1.00	20 EA
Universal SkirtRail Spacer, 40 mm	232-02497	\$1.00	20 EA
Sealing Wood Screw, #14 X 2 1/4", 1/2" Hex, SS	242-10010	\$0.75	80 EA

Railless Wire Management & Accessories

Description	SKU	MSRP	QTY*
SnapNrack Grounding Lug	242-92202	\$4.70	20 EA
MLPE Frame Attachment Kit	242-02151	\$4.68	20 EA
Smart Clip II	232-01173	\$0.44	100 EA
Smart Clip XL	232-01176	\$0.61	100 EA
Wire Saver	242-92262	\$2.82	20 EA
FlashBox™	242-10028	\$40.00	1 EA
FlashBox™ Internal Wiring Kit	242-10048	\$50.00	20 EA
NEW Universal Conduit Mount, Simple	242-10054	\$7.42	20 EA
NEW Universal Conduit Mount, Leveling	242-10059	\$9.66	20 EA
SpeedSeal™ J Box XL, Comp Mount	242-92128	\$52.50	1 EA
Add-A-Lip Box Frame Adapter, Black	242-01101	\$6.05	20 EA

NEW

NEW

NEW

For additional Universal SkirtRail SKUs and QTYs, please refer to the **SkirtRail Components Table** on page 6.
For additional railless Wire Management Solutions & Accessories, please refer to the **Railless Wire Management & Accessories Table** on page 6.

* QTY (Quantity) listed is the standard package and minimum order quantity. SnapNrack products are sold through distribution and may be available as individual units.

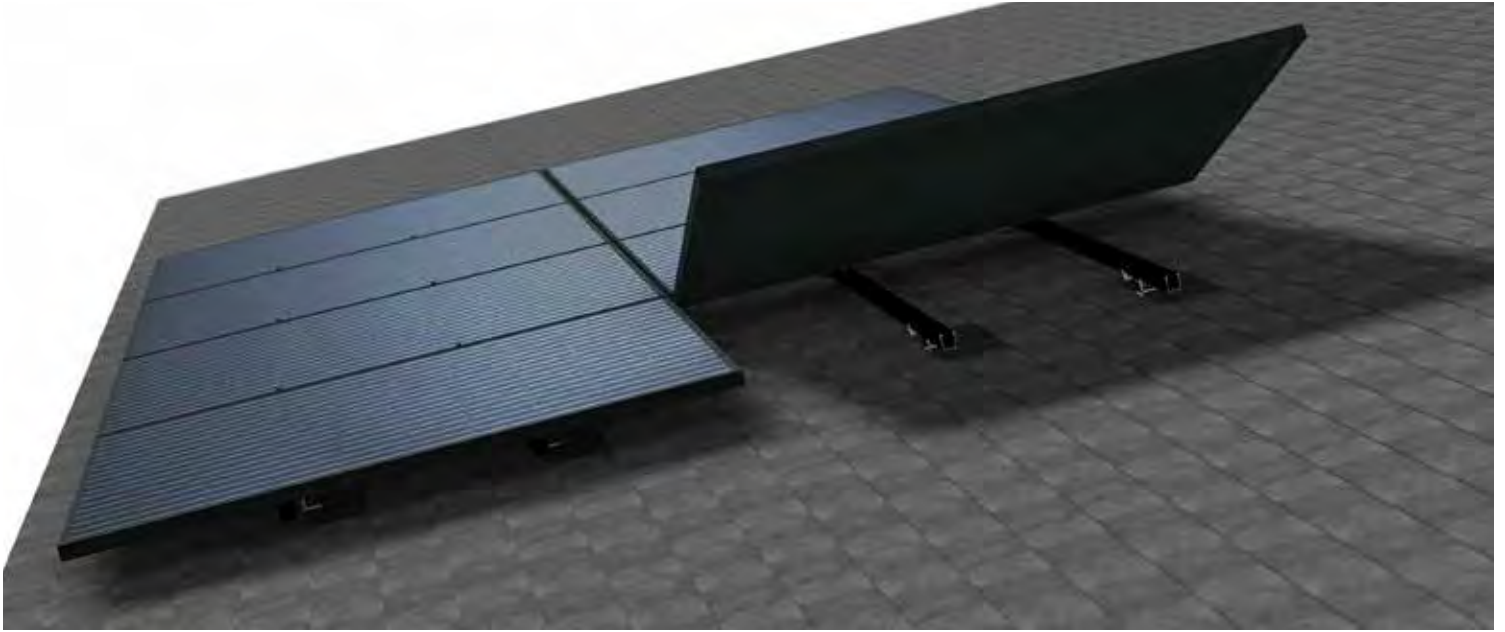

SnapRack Ultra Rail **The Ultimate Value in Rooftop Solar**

Ultra Rail is the ultimate rail solution for mounting solar modules on the roof. The entire system is a snap to install utilizing pre-assembled Ultra Rail Mounts that include snap-in brackets for attaching rail. Snap-in module clamps provide an intuitive install experience installers know and love.

- Industry-leading aesthetics with Universal End Clamps & snap-in End Caps that make the mounting system invisible underneath the array.
- Unparalleled wire management solutions with accessories such as Junction Boxes, Universal Wire Clamps, MLPE Attachment Kits, and Conduit Clamps.
- Low profile rail maintains the open channel with room for running wires resulting in a top quality finished install.
- UR-45 a lightweight rail profile that's suited for all geographic regions, with varying span capabilities

More Info

[Ultra Rail Product Page](#)

Ultra Rail Configuration Tool

Design a system & download a BOM to quote with the online Configuration Tool

Visit Resource Library

Download Structural Engineering, Installation Manuals & System Drawings

UR-45 Rail & Accessories



UR-45 Rail, Black



UR-45 Rail, Mill



UR-40 & UR-45 Splice



UR-45 End Cap with
UR-45 Rail

UR-45 Rail			
Description	SKU	MSRP	QTY*
UR-45 Rail, 94", Mill (Bundle of 144, priced as each)	232-10097	\$30.47	144 EA
UR-45 Rail, 94", Black (Bundle of 144, priced as each)	232-10098	\$33.29	144 EA
UR-45 Rail, 172", Black (Bundle of 144, priced as each)	232-10096	\$60.91	144 EA
UR-45 Rail Accessories			
Description	SKU	MSRP	QTY*
UR-40 & UR-45 Splice, Silver	242-01213	\$8.70	20 EA
UR-40 & UR-45 Splice, Black	242-01214	\$9.24	20 EA
UR-45 End Cap	232-10101	\$0.70	20 EA

* QTY (Quantity) listed is the standard package and minimum order quantity. SnapRack products are sold through distribution and may be available as individual units.

Flashing & L Foot Attachments



Composition Shingle Attachments

Description	SKU	MSRP	QTY*
UltraFoot, Rafter, Black	242-10056	\$9.50	20 EA
UltraFoot, Deck, Black	242-10057	\$11.50	20 EA
UltraFoot, Anchor, Black	242-10058	\$11.50	20 EA
UR SpeedSeal™ Foot, Black	242-02167	\$10.50	20 EA
DeckAnchor™ 2.5	242-10035	\$1.80	40 EA
Sealing Washer Lag, 4 1/2", SS	242-02168	\$1.25	20 EA
Sealing Wood Screw, #14 X 2 1/4", 1/2" Hex, SS	242-10010	\$0.75	80 EA
Ultra Rail Umbrella L Foot, Black	242-01220	\$7.74	20 EA
Comp Flashing, 9" x 12", Black Alum (requires Umbrella Lag)	232-01375	\$5.51	20 EA
Umbrella Lag, 4"	242-92266	\$1.55	20 EA

Ultra Rail Attachment Components

Description	SKU	MSRP	QTY*
Ultra Rail Leveling Spacer, Black	242-05161	\$2.87	20 EA
Ultra Rail Mounting Hardware, Black	242-01230	\$4.24	20 EA
Ultra Rail Mounting Hardware, Silver	242-01229	\$4.08	20 EA
Ultra Rail All Purpose L Foot (90°), Black	242-01239	\$7.04	20 EA
Ultra Rail All Purpose L Foot (90°), Silver	242-01223	\$7.01	20 EA

 **Note that the fasteners are sold separately from the Composition Shingle Roof Attachments listed above. Required fasteners are as follows:**

One (1) Sealing Washer Lag, 242-02168, is required for each Ultra Rail SpeedSeal™ Foot or UltraFoot, Rafter attachment.

One (1) Sealing Washer Lag, 242-02168, when rafter mounting or Two (2) DeckAnchors, 242-10035, when deck mounting is required for each UltraFoot, Anchor.

Two (2) Sealing Wood Screws, 242-10010, when rafter mounting or Four (4) Sealing Wood Screws, 242-10010, when deck mounting is required for each UltraFoot, Deck.



Module Clamps & SkirtRail

SnapNrack Module Attachments - Ultra Rail - S200

Module Clamps are available for all PV module frame sizes (30-46 mm). **Universal End Clamps** are a unique one-size-fits-all that slips inside the module frame – completely out of sight. The rails are cut flush with the modules and finished with SnapNrack End Caps to create a system with a flush, clean line. All Module Clamps work with Ultra Rail, and Series 200 Ground Mount. Module Clamps ship pre-assembled, ready to install.



Ultra Rail Mid Clamp,
Black



Universal End Clamp



Ultra Rail End Clamp,
Black



Universal SkirtRail
Frame Mount



Universal SkirtRail Cap

Mid Clamps			
Description	SKU	MSRP	QTY*
Ultra Rail Mid Clamp, Silver	242-02070	\$4.64	20 EA
Ultra Rail Mid Clamp, Black	242-02071	\$4.87	20 EA
End Clamps			
Description	SKU	MSRP	QTY*
Universal End Clamp	242-02215	\$6.28	20 EA
Ultra Rail End Clamp, Silver	242-02072	\$5.77	20 EA
Ultra Rail End Clamp, Black	242-02073	\$6.06	20 EA

Universal SkirtRail			
Description	SKU	MSRP	QTY*
Universal SkirtRail Frame Mount	242-10006	\$8.00	20 EA
Universal SkirtRail Cap	232-10019	\$2.40	20 EA
Universal Double Portrait SkirtRail, 83", Black, (Bundle of 72, priced as each)	232-02493	\$52.67	72 EA

* QTY (Quantity) listed is the standard package and minimum order quantity. SnapNrack products are sold through distribution and may be available as individual units.

Tile Roof Solutions



Ultra Rail Tile Roof Hook F



Ultra Rail Adjustable Tile Hook



Tile Hook Replacement Flashing, S



Tile Hook Replacement Flashing, W

Tile Roof Hooks

Description	SKU	MSRP	QTY*
Ultra Rail Tile Roof Hook F	242-01247	\$11.95	20 EA
Ultra Rail Tile Roof Hook WS	242-01248	\$15.62	20 EA
Ultra Rail Adjustable Tile Hook	242-02729	\$16.38	10 EA
Sealing Wood Screw, #14 X 2 1/4", 1/2" Hex, SS	242-10010	\$0.75	80 EA



Ultra Rail Adjustable Tile Hook is the one Tile Hook for all tile roofs with install compatibility on S/W and Flat tile profiles.

Ultra Rail Tile Roof Hook F is for application on flat tile roofs only. Ultra Rail Tile Roof Hook WS is for application on both W & S Shaped tile roofs.

Ultra Rail Tile Hooks ship pre-assembled with the Ultra Rail Mount.

Ultra Rail Adjustable Tile Hook & Ultra Rail Tile Roof Hook WS can be mounted directly to the roof deck with the use of 6 to 8 Sealing Wood Screws (242-10010).

Tile Hook Replacement Flashing

Description	SKU	MSRP	QTY*
Tile Hook Replacement Flashing, Flat	232-60055	\$15.93	20 EA
Tile Hook Replacement Flashing, S	232-60056	\$15.93	20 EA
Tile Hook Replacement Flashing, W	232-60057	\$15.93	20 EA



Ultra Rail Tile Hook Replacement Flashings are for Tile Hook installations when necessary to replace broken tiles.

Deck Level Flashing for Tile

Description	SKU	MSRP	QTY*
PS45 Deck Level Flashing Set, (1) 9x9 & (1) 4X13	242-02723	\$7.98	20 Sets
PS45 Deck Level Flashing Set, (1) 5X13 & (1) 4X17	242-02728	\$8.98	20 Sets
Protecto-Tak Spray Adhesive	131-01347	\$32.99	20 EA

* QTY (Quantity) listed is the standard package and minimum order quantity. SnapRack products are sold through distribution and may be available as individual units.

Wire Management Solutions

SnapNrack Wire Management - Ultra Rail - S200

SnapNrack offers the largest set of mounting accessories to enhance the install process. SnapNrack **Wire Management Solutions** comprise a set of dedicated components to reliably and cost-effectively secure PV module and microinverter leads. All components are made of materials which have been selected for their ability to handle high UV exposure and extreme rooftop temperatures common under solar arrays.



Junction Box XL



FlashBox™



OmniLug™



Wire Retention Clip



Universal Wire Clamp

Wire & Electronics Management			
Description	SKU	MSRP	QTY*
Junction Box R for Rail	242-01104	\$35.11	1 EA
Junction Box XL for Rail	242-92120	\$47.20	1 EA
SpeedSeal™ J Box XL, Comp Mount	242-92128	\$52.50	1 EA
FlashBox™	242-10028	\$40.00	1 EA
FlashBox™ Internal Wiring Kit	242-10048	\$50.00	20 EA
Universal Wire Clamp for Rail	242-02150	\$4.06	20 EA
Snap-in Wire Retention Clip	232-01106	\$0.47	20 EA
Smart Clip II	232-01173	\$0.44	100 EA
Smart Clip XL	232-01176	\$0.61	100 EA
MLPE Frame Attachment Kit	242-02151	\$4.68	20 EA

Grounding Solutions			
Description	SKU	MSRP	QTY*
OmniLug™	242-10034	\$4.49	20 EA

 The SnapNrack OmniLug (242-10034) is both a ground lug and a MLPE Rail Attachment assembly for SnapNrack Ultra Rail Systems.

Conduit Mounts			
Description	SKU	MSRP	QTY*
NEW Universal Conduit Mount, L Foot	242-10051	\$7.95	20 EA
NEW Universal Conduit Mount, Tile	242-10052	\$6.71	20 EA
NEW Universal Conduit Mount, Simple	242-10054	\$7.42	20 EA
NEW Universal Conduit Mount, Leveling	242-10059	\$9.66	20 EA



Universal Conduit Mount, Leveling



Universal Conduit Mount, Tile



Universal Conduit Mount, L Foot



Universal Conduit Mount, Simple

Tilt System Roof Attachments

Roof Type	Description	SKU	MSRP	QTY*
Foam Roof	Select this SKU Ultra Rail Tilt-Mount Kit, 10"	242-10020	\$23.71	20 EA
	Plus ONE of these SKUs	Ultra Rail Tilt-Mount Kit, 14"	\$24.75	20 EA
		Ultra Rail Tilt-Mount Kit, 23"	\$29.75	10 EA
Flat Roof	Select this SKU Ultra Rail Tilt-Mount Kit, 5½"	242-10019	\$20.64	20 EA
	Plus ONE of these SKUs	Ultra Rail Tilt-Mount Kit, 10"	\$23.71	20 EA
		Ultra Rail Tilt-Mount Kit, 14"	\$24.75	20 EA
		Ultra Rail Tilt-Mount Kit, 23"	\$29.75	10 EA
	Ultra Rail Simple Tilt Front Leg 5°	242-10060	\$8.00	20 EA
	Ultra Rail Simple Tilt Front Leg 5° Portrait	242-10062	\$12.00	20 EA
Ultra Rail Simple Tilt Front Leg 5° Landscape	242-10061	\$10.00	20 EA	

 Ultra Rail Tilt-Mount Kits include include the new **OmniBase™**, a Standoff Shaft and Ultra Rail Tilt Clamp (Standoff Clamp, L Foot, and Ultra Rail Mounting Hardware).
Please refer to Ultra Rail Tilt Angle Table (Nominal).

For Foam Roofs, order **Ultra Rail Tilt-Mount Kit, 10"** for front leg and **Ultra Rail Tilt-Mount Kit, 14"** for rear leg to obtain a desired **low fixed tilt (5° - 14°)**. Order **Ultra Rail Tilt-Mount Kit, 10"** for front leg and **Ultra Rail Tilt-Mount Kit, 23"** for rear leg to obtain a desired **high fixed tilt (15° - 28°)**.

Please refer to Ultra Rail Tilt Angle Table (Nominal) to obtain desired tilt angles for 5° - 30° Fixed Tilt Kit Standoffs with Ultra Rail Tilt Clamps.

Simple Tilt hardware *can be* installed with Standoffs and such, they are not approved in SnapNrack Structural Engineering Reports.

Simple Tilt requires 4ft spacing for portrait modules and 2ft spacing for landscape modules between mounts front to rear, and is only available as a direct mount to roof structure.

Ideal for use with E-Curb (pourable penetration sealant) - available for purchase as special order, Simple Tilt Attachments are for application on flat roofs only.

Note that Simple Tilt SKUs are referred to in Structural Documentation as Tilt Leg Plus.

Tilt & Standoff Systems



Ultra Rail Tilt-Mount with OmniBase™



Ultra Rail Simple Tilt Portrait



Ultra Rail OmniBase
(SOLD IN KITS)

Ultra Rail Tilt Angle Table (Nominal)

5° - 30° Fixed Tilt Kits - Standoffs with Ultra Rail Tilt Clamps

Front to back attachment spacing	Landscape			Portrait		
	5 1/2" & 10" Standoffs	5 1/2" & 14" Standoffs	5 1/2" & 23" Standoffs	5 1/2" & 10" Standoffs	5 1/2" & 14" Standoffs	5 1/2" & 23" Standoffs
16"	16°	28°	N/A	N/A	N/A	N/A
24"	10°	20°	N/A	N/A	N/A	N/A
32"	8°	15°	28°	8°	15°	28°
48"	N/A	N/A	N/A	5°	10°	20°

Notes:

1. Table is based on 60 cell modules
2. Table assumes mounting zone on portrait modules not exceeding 25% of module length
3. Maximum tilt angle allowed = 30° relative to horizontal
4. All tilt ups must have 5-1/2" Standoff in front

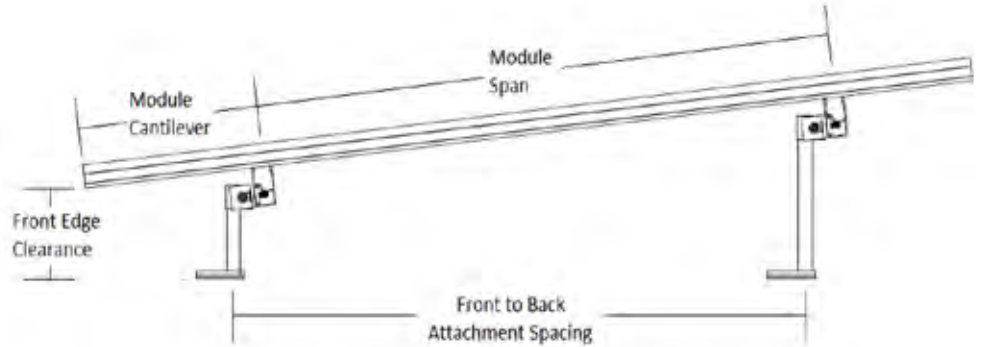

Ultra Rail Simple Tilt System

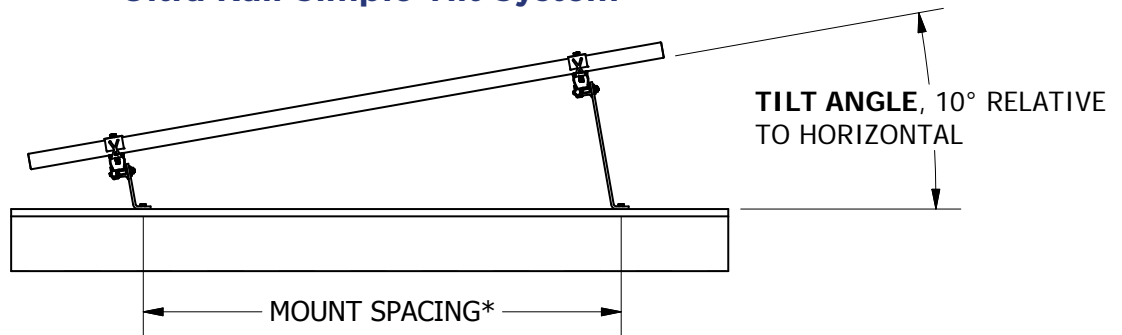

*4'-0" PORTRAIT
2'-0" LANDSCAPE

* QTY (Quantity) listed is the standard package and minimum order quantity. SnapRack products are sold through distribution and may be available as individual units.



SnapRack & S-5! Metal Roof Solutions

Description	SKU	MSRP	QTY*
All Purpose L Foot ft. S-5! CorruBracket 100T	242-10039	\$17.85	20 EA
All Purpose L Foot ft. S-5! CorruBracket	242-10040	\$20.83	20 EA
All Purpose L Foot ft. S-5! SolarFoot	242-10041	\$16.01	20 EA
Ultra Rail Mounting Clamp feat. S-5! ProteaBracket (USA)	242-10042-USA	\$26.03	20 EA
All Purpose L Foot ft. S-5! S-5-N Mini	242-10043	\$17.70	20 EA
All Purpose L Foot ft. S-5! VersaBracket-47	242-10044	\$13.03	20 EA

 Please note that **SKU 242-10039 & SKU 242-10042-USA** ship with (4) S-5! 1/4" x 1" metal-to-metal self-piercing screws. Additional screw for other applications should be purchased separately via your distributor.



All Purpose L Foot ft. S-5! CorruBracket



All Purpose L Foot ft. S-5! SolarFoot



UR Mounting Clamp ft. S-5! ProteaBracket (USA)



All Purpose L Foot ft. S-5! CorruBracket 100T



All Purpose L Foot ft. S-5! S-5-N Mini



All Purpose L Foot ft. S-5! VersaBracket-47

Metal Roof Attachments

Description	SKU	MSRP	QTY*
Ultra Rail Metal Roof Base w/ L Foot	242-02158	\$13.89	20 EA
Ultra Rail Wide Base Seam Clamp w/ L Foot & Lock	242-05159	\$14.61	20 EA
Ultra Rail All Purpose L Foot (90°), Silver	242-01223	\$6.68	20 EA
Ultra Rail Hanger Bolt Clamp	242-01128	\$6.53	20 EA
Metal Roof Base	242-02036	\$7.21	20 EA
Wide Base Seam Clamp	242-05001	\$8.61	20 EA



Ultra Rail Metal Roof Base w/ L Foot



OmniShield™



Ultra Rail Flush-Mount
5 1/2"
Includes OmniBase™



Array Edge Screen
Fastener

Standoff Mount Roof Attachments

Description	SKU	MSRP	QTY*
Ultra Rail Flush-Mount Kit, 5 1/2"	242-10016	\$16.91	20 EA
Ultra Rail Flush-Mount Kit, 7"	242-10017	\$17.93	20 EA
Ultra Rail Flush-Mount Kit, 8 1/2"	242-10018	\$19.29	20 EA
OmniShield™	232-10042	\$26.60	20 EA



Standoff Mount Roof Attachments are sold in kits which include the new **OmniBase™** roof attachment base.

Standoff Mount Roof Accessories

Description	SKU	MSRP	QTY*
Rubber Rain Collar	232-01000	\$1.18	20 EA
Standoff Flashing, Verde 1.0STF, Skinny Cone for Tile, 20" x 20" x 3", Dead Soft Alum	175-05001	\$22.48	25 EA
Standoff Flashing, Verde 1.0SSO, Deck Level for 1-Hole Base, 10" x 12" x 1", Galv	175-05005	\$9.11	25 EA

Array Edge Screen

Description	SKU	MSRP	QTY*
Array Edge Screen, 6" Black (100')	232-04077	\$112.56	1 EA
Array Edge Screen, 8" Black (100')	232-04076	\$137.85	1 EA
Array Edge Screen Fastener	242-04105	\$2.82	100 EA
Add-A-Lip Box Frame Adapter, Black	242-01101	\$6.05	20 EA

* QTY (Quantity) listed is the standard package and minimum order quantity. SnapRack products are sold through distribution and may be available as individual units.



SnapRack Series 200 **The Adaptable High Quality Solution for Ground Mount Installations**

The Series 200 Ground Mount System is designed to attach easily to a standard 1 ½” galvanized pipe structure using structural pipe fittings. Using a standard three to four-module high assembly, the system is efficient and flexible while optimizing materials and minimizing system footprint. Industry leading installation times are achieved with unique snap-in fasteners.

- Assembles easily using snap-in bonding pipe clamps that connect the rails
- Fully compatible with all SnapRack module clamps and accessories
- Ground rail channel keeps wires neatly organized providing a clean finished look to every install
- Industry’s largest offering of Wire Management accessories include snap-in Junction Boxes, Universal Wire Clamps, as well as ground rail channel to keep wires neatly organized
- Maximum versatility with the ability to configure easily to desired tilt between 0 and 45 degrees
- Using pipe structural fittings, labor hours to install the system are typically less than required for a more complicated racking system not using standardized components

More Info

[Series 200 Ground Mount Product Page](#)

Configuration Tool

Design a system & download a BOM to quote with the online Configuration Tool

Visit Resource Library

Download Structural Engineering, Installation Manuals & System Drawings

Series 200 Components



Ground Rail

Series 200 Rail			
Description	SKU	MSRP	QTY*
Ground Rail, 172", Silver (Bundle of 112)	232-02542-USA	\$122.29	112 EA
Ground Rail End Cap	232-01043	\$2.87	20 EA
Ground Rail Splice	242-04009	\$16.88	20 EA



Bonding Pipe Clamp

Series 200 Structural Fittings			
Description	SKU	MSRP*	QTY*
Bonding Pipe Clamp for 1 1/2" Pipe	242-09004	\$7.48	20 EA
Single Socket Tee, Hollaender (5EXT-8), 1 1/2", AL-MG	172-05818	\$29.87	50 EA
Single Adjustable Socket Tee, Hollaender (17-8), 1 1/2", AL-MG	172-05803	\$30.87	50 EA
Double Adjustable Socket Tee, Hollaender (19E-8), 1 1/2", AL-MG	172-05804	\$39.93	35 EA
Rectangular Base Flange, Hollaender (47-9) 2", AL-MG	172-05822	\$52.77	35 EA
Rectangular Base Flange, Hollaender (46-8), 1 1/2", AL-MG	172-05807	\$28.70	40 EA
Plug End, Hollaender (62-8), 1 1/2" Sched 40, AL	172-05808	\$7.85	200 EA
Adjustable Reducing Elbow/Tee, Hollaender (17-98) 2" x 1 1/2", AL-MG	172-05819	\$47.50	30 EA
(19-98) 2" x 1 1/2", AL-MG	172-05820	\$69.47	25 EA
Reducing Tee, Hollaender (5-89) 1 1/2" x 2", AL-MG	172-05821	\$38.11	35 EA



Double Adjustable Socket Tee, Hollaender



Reducing Tee, Hollaender



Adjustable Reducing Elbow/Tee, Hollaender



Rectangular Base Flange, Hollaender

* MSRP from third party manufacturers like Hollaender are subject to change without 30 day notice.

* QTY (Quantity) listed is the standard package and minimum order quantity. SnapNrack products are sold through distribution and may be available as individual units.

WHILE SUPPLIES LAST!

While Supplies Last

Description	SKU	MSRP	QTY*
Comp Flashing, 9" x 12", Silver Alum (requires Umbrella Lag)	232-01376	\$5.03	20 EA
Comp Flashing, 9" X 12", Black Galvalume (requires Umbrella Lag)	232-01377	\$5.20	20 EA
Ultra Rail Umbrella L Foot, Silver	242-01219	\$6.30	20 EA
UR SpeedSeal™ Foot, Silver	242-02163	\$9.50	20 EA
Ultra Rail AnchorFoot™, Black	242-10038	\$11.50	20 EA
Corrugated Straddle Block	232-02421	\$3.00	20 EA
Ultra Rail Simple Tilt Front Leg 10°	242-03217	\$8.00	20 EA
Ultra Rail Simple Tilt Back Leg 10° Landscape	242-03216	\$10.00	20 EA
Ultra Rail Simple Tilt Back Leg 10° Portrait	242-03215	\$12.00	20 EA
SpeedSeal™ Track	232-01464	\$8.75	20 EA
SpeedSeal™ Track (USA)	232-01464-USA	\$10.97	20 EA
Conduit Support Assembly, 3/4" EMT	242-02730	\$5.70	20 EA
Conduit Support Assembly, 1" EMT	242-02731	\$6.21	20 EA
SpeedSeal™ Conduit Mount Kit, 3/4" EMT	242-05164	\$9.10	20 EA
SpeedSeal™ Conduit Mount Kit, 1" EMT	242-05165	\$9.91	20 EA
Conduit Support for Tile, 3/4" EMT	242-02104	\$5.70	20 EA
Junction Box XL with Comp Kit	242-92121	\$54.95	1 Kit
Flash Track Universal Wire Clamp	242-92641	\$6.44	20 EA



AnchorFoot™



Comp Flashing,
9" X 12", Black Galvalume



Umbrella L Foot, Silver



SpeedSeal™ Track



Corrugated Straddle
Block



SpeedSeal™ Conduit
Mount Kit, 1" EMT



Conduit Support
3/4" EMT



Flash Track Universal
Wire Clamp

Place Your Order

Contact your SnapNrack distributor, which can be found at www.SnapNrack.com/where-to-buy, contact us directly at contact@snapnrack.com, or call us **Toll Free at (877) 732-2860** for technical support.

SnapNrack distributors have trained knowledgeable staff that can provide product design and ordering assistance.

MSRP

Prices published in this document are Manufacturer Suggested Retail Prices (MSRP) and should be used for reference only. Prices are subject to change without notice. The quantity (QTY) shown is based on the standard package and is the recommended order quantity.

Warranty

All SnapNrack products are covered by a **25-year limited warranty**. For complete details please view the online SnapNrack's Manufacturers Limited Product Warranty.

SnapNrack[®]

877-732-2860

•

www.SnapNrack.com

•

contact@snapnrack.com



SnapNrock®